

**TVS** 



**TVS**  
***Jupiter***

**OWNER'S MANUAL**

**BS-VI**



SCAN FOR 24X7  
ROADSIDE ASSISTANCE NOW

# WE GO THE DISTANCE WHEN IT COMES TO YOUR ASSISTANCE.

MAKE YOUR RIDES HASSLE-FREE AND STRESS-FREE  
WITH SERVICE BEYOND JUST ASSISTANCE.

Sign up for our 24X7 Roadside Assistance and enjoy  
quick and efficient service anytime, anywhere.





**Drive In.**

**Drive Out.**



**Say bye-bye to waiting time  
for servicing your bike.**

**Get your vehicle serviced in 1 hour at no additional cost. Contact your nearest Dealership for details.<sup>†</sup>**

<sup>†</sup>Facility available at selected Dealerships only. Terms and conditions apply





# Busy Life? Easy Servicing!

Now, service your bike anywhere, anytime.

- ★ Service the vehicle at your door step.
- ★ Available for regular maintenance or breakdown service only.
- ★ Offered at nominal convenience charges.

Contact your nearest Dealership for details.<sup>†</sup>

<sup>†</sup>Facility available at selected Dealerships only. Terms and conditions apply





# Busy Life? Easy Servicing!

Now, service your bike anywhere, anytime.

- ★ Service the vehicle at your door step.
- ★ Available for regular maintenance or breakdown service only.
- ★ Offered at nominal convenience charges.

**Contact your nearest Dealership for details.<sup>†</sup>**

<sup>†</sup>Facility available at selected Dealerships only. Terms and conditions apply

EXPRESS SERVICE	I
EXPERT ON WHEELS	II
PICKUP AND DROP	III
CONTENTS	IV
CONTACT(S) FOR SUPPORT	1
INTRODUCTION	5
UNIQUE FEATURES OF TVS JUPITER ZX	6
ACCESSORIES	10
FOREWORD	11
NOTICE	12
SAFETY INFORMATION	13
RUNNING-IN INFORMATION	14
SAFE RIDING TIPS	15
KNOW YOUR TVS JUPITER ZX	19
RIDING YOUR TVS JUPITER ZX	72
MAINTENANCE	76
WARRANTY AND SERVICES	102
TECHNICAL SPECIFICATIONS	109
GENERAL INFORMATION	114

**Incase you need any Clarification please contact  
TVS Motor Company Authorised Main Dealer / Authorised Dealer**

**Or**

**TVS Motor Company's Area Offices (flip over for addresses)**

**Or**

**Toll Free Number : 1800-258-7111**

**Email : [customercare@tvs-motor.com](mailto:customercare@tvs-motor.com)**

**Disclaimer :** TVS Motor Company or any of its officials / Authorized Main dealer / Authorized Dealer do not ask customers for bank / card / wallet details / authentication. In case you face any such claim, please report to the relevant local authorities immediately.

## CONTACT AT OUR AREA OFFICES

### TAMILNADU-1, 3 & 4

#### 1. TVS Motor Company Limited

V Floor, Gee Gee Universal,  
No. 2, MC Nichols Road,  
Chetpet, Chennai - 600 031.  
Phone : 044-28361651/28361654  
Email : AO.Chennai@tvs motor.com  
AO.Madurai@tvs motor.com

### TAMILNADU-2

#### 2. TVS Motor Company Limited

No. 10, 2nd floor,  
Shree Shanmugapriya Towers,  
Kannuswamy Street,  
Behind Hotel Annapoorna,  
R S Puram, Coimbatore - 641 002.  
Phone : 0422-4350060/2541035  
Email : AO.Coimbatore@tvs motor.com

### KERALA

#### 3. TVS Motor Company Limited

Ambady Towers, Second Floor,  
Door No. 27/631, A6,  
Edappally-Pookkattupady Road,  
Edappally PO., Cochin - 682 024.  
Phone : 0484-2544578/2556938  
Email : AO.Cochin@tvs motor.com

### KARNATAKA-1, 2 & GOA

#### 4. TVS Motor Company Limited

No. 600, Anand Surya, 2nd Floor,  
15th Cross, 6th Phase, JP Nagar,  
Opp. BMTC Bus Stop,  
Bangalore - 560 078.  
Phone : 080-26653433  
Email : AO.Bangalore@tvs motor.com

### ANDHRAPRADESH & TELANGANA

#### 5. TVS Motor Company Limited

Rukumani Towers, First Floor,  
No. 3-11-30, Plot No. 11,  
Paigha Colony, Behind Anand Theater,  
Secunderabad - 500 003.  
Phone : 040-27840590/27844419  
Email : AO.Hyderabad@tvs motor.com  
AO.Vijayawada@tvs motor.com

### MAHARASHTRA-1 & 2

#### 6. TVS Motor Company Limited

No. 401, 4th Floor, The Chambers,  
Plot No. 4/12/3, Near Ganapati Chowk,  
Viman Nagar, Pune - 411 014.  
Phone : 020-26632112/26632110  
Email : Service.pune@tvs motor.com

### MAHARASHTRA-3 & CHATTISGARH

#### 7. TVS Motor Company Limited

No. 502B, 6th Floor, B Wing,  
Shriram Shyam Towers,  
Near LIC Square, Sardar,  
Nagpur - 440 001.  
Phone : 0712-2569932  
Email : Service.Nagpur@tvs motor.com  
AO.Raipur@tvs motor.com

### GUJARAT

#### 8. TVS Motor Company Limited

1208-1213, Shivalik Satyamev,  
Below Bopal Over Bridge,  
Ambli-SP Ring Road Junction, Bopal,  
Ahmedabad- 380 058.  
Phone : 079-65443748  
Email : AO.Ahmedabad@tvs motor.com



**MADHYA PRADESH-1 & 2****9. TVS Motor Company Limited**

No. 211-212, 2nd Floor,  
Chinar Incube Business Centre,  
Chinar Fortune City,  
Near Brindhavan Dhaba,  
Hosangabad Road,  
Bhopal - 462 026.  
Phone : 0755-2499406/2499306  
Email : AO.Bhopal@tvs motor.com  
AO.Indore@tvs motor.com

**RAJASTHAN-1 & 2****10. TVS Motor Company Limited**

Plot No. 17-18,  
2nd Floor of National Motors Building,  
Jhotwara Industrial Area,  
Jaipur - 302 012.  
Phone : 0141-5150901/5150902  
Email : AO.Jaipur@tvs motor.com  
AO.Udaipur@tvs motor.com

**DELHI & HARYANA****11. TVS Motor Company Limited**

D-3 & D-4, 2nd Floor,  
Sector - 10, Noida,  
Uttar Pradesh - 201 301.  
Phone : 011-29834640/29834773  
Email : AO.Delhi@tvs motor.com

**PUNJAB & CHANDIGARH****12. TVS Motor Company Limited**

4th Floor, Royal Business Park,  
Chandigarh Ambala Highway,  
Zirkapur - 140 603.  
Phone : 01762-464777/465777  
Email : AO.Chandigarh@tvs motor.com

**UTTAR PRADESH WEST****13. TVS Motor Company Limited**

D-3 & D-4, 2nd Floor,  
Sector - 10, Noida,  
Uttar Pradesh - 201 301.  
Phone : 011-29834640/29834773  
Email : AO.Delhi@tvs motor.com

**UTTAR PRADESH CENTRAL & EAST****14. TVS Motor Company Limited**

1st Floor, Cyber Tower, TC-34/V-2,  
Vibhuti Khand, Gomti Nagar,  
Lucknow - 226 010.  
Phone : 0522-4918300/4918301  
Email : AO.Lucknow@tvs motor.com

**WEST BENGAL****15. TVS Motor Company Limited**

Ground Floor & First Floor,  
133 A. S. P. Mukherjee Road,  
Opp. Tollygunge Police Station,  
Kolkatta - 700 026.  
Phone : 033-24617096/24617092  
Email : AO.Kolkatta@tvs motor.com

**BIHAR****16. TVS Motor Company Limited**

N-Plaza, Jamal Road,  
P.S. Kotwali,  
Patna - 800 001.  
Phone : 0612-2200068/2200069  
Email : AO.BNJ@tvs motor.com

## **ORISSA & JHARKHAND**

### **17. TVS Motor Company Limited**

No. 303, 3rd Floor,  
Creative Plaza, Rasulgarh,  
Bhubaneswar - 751 010.  
Phone : 0674-2580019  
Email : AO.Bhubaneswar@tvsmotor.com

## **NORTH EAST STATES**

### **18. TVS Motor Company Limited**

147, Udayan, Ganesh Guri,  
Near Hotel D Courtyard,  
R G B. Road, Guwahati - 781 005.  
Phone : 0361-2202030/2202031  
Email : AO.Guwahati@tvsmotor.com

### INTRODUCING THE EXTREMELY NEW TVS JUPITER ZX

Since its inception, **TVS Jupiter** has represented novelty. With its sweeping silhouette, unrivalled comfort and class-leading features, it truly exhibits our philosophy of 'Zyada Ka Fayda'.

Our ability to develop tailor-made scooters for you is the inspiration behind the creation of **TVS Jupiter ZX**. Meticulously designed and lovingly crafted, **TVS Jupiter ZX**'s captivating exterior is pure indulgence. It is the scooter that adapts to your needs and can be uniquely suited to match your style, status and personality. It is the extremely new **TVS Jupiter ZX**.

## UNIQUE FEATURES OF TVS JUPITER ZX

### FULLY DIGITAL CONNECTED INSTRUMENT CLUSTER WITH ON-BOARD DIAGNOSTIC

Your scooter is fitted with 'Fully Digital Connected Instrument Cluster'. This first-in class cluster housed perfectly in the headlamp housing of your scooter. An Engine Malfunction Indication lamp is added to glow whenever any engine related fault is present in vehicle.



### SMARTXONNECT-BLUETOOTH CONNECTIVITY

The connected instrument cluster of your scooter has a inbuilt Bluetooth® connectivity through which you can connect your Android™ smart phone / iPhone® to access the features like caller ID, SMS and missed call notification, navigation in the cluster and voice assist, ride stats share and incase of Andorid smart phone the last parked location of the vehicle.

### VOICE ASSIST

Your scooter is now provided with voice assist. You can use your voice to control various functions like speedometer brightness, enable high speed alerts, etc. You can use your voice through a connected audio device like a Bluetooth® headphone and control vehicle functions like starting navigation instructions to a particular location. You can also set location for navigation, ask for number of missed calls etc. over voice.



### ECONOMETER®

Your scooter's speedometer has ECONOMETER® which indicates whether you are riding in Economy Mode or Power mode. This is an unique feature of your scooter which guides you to ride your scooter fuel efficiently. Refer page No. 26 for details.



## INTEGRATED GENERATOR (ISG)\*

'Integrated Starter Generator' (ISG) system has delivers a noiseless start of the vehicle. An ISG malfunction indicator is also added to the speedometer.

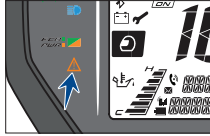

## STARTER

## 'TVS intelliGO'\*

An intelligent start/stop system that further enhances fuel efficiency. Easy on your pocket and kinder to the environment. Refer page No. 27 for details.



## LOW FUEL INDICATOR

'Low Fuel Indicator' is yet another unique feature of your scooter which indicates you to refill the fuel, when the fuel in the tank goes below minimum safe level. Refer page No. 29 for details.

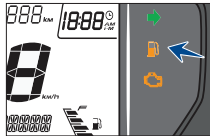

## ALL IN ONE LOCK

Your scooter has all in one lock that unlocks the seat and fuel tank cap at the ignition lock itself. Refer page No. 24 for details.



## UNIQUE PASS-BY SWITCH

Pass-by Switch is a feature which allows you to easily switch between high & low beam of the head lamp with easy press and auto release. It is helpful especially while overtaking. Refer page No. 61 for details.



## 'TVS intelliGO' SWITCH\*

An exclusive intelliGO switch is provided to switch 'OFF' and 'ON' the intelliGo system as and when required. Refer page No. 62 for details.



\* Applicable only for disc brake version

### ENGINE Kill SWITCH\*\*

'Engine Kill Switch' is an another unique feature in scooter which allows you to shut the engine without switching OFF the ignition.



### EXTERNAL FUEL FILL

You can get petrol filled without even getting out of your seat.



### RETRACTABLE BAG HOOKS

Your scooter has two retractable Bag Hooks to carry light luggage like carry bags weighing upto 3 kg.

One hook is located below the handle bar on the rear panel and the other one is located on the cover front below the front end of seat.



### TELESCOPIC FRONT FORK

Your Scooter has Motorcycle-like 'Telescopic Front Suspension' for extreme comfort for excellent riding comfort even on bad roads.



### ADJUSTABLE REAR SHOCK ABSORBER

Your Scooter comes with Adjustable Shock Absorber, a first-in-the-industry feature. This allows you to adjust the required level of hardness / softness as per the usage requirement at just the push of a lever.



### TUBELESS TYRES

Another important unique feature in your scooter is 'Tubeless Tyres'. Tubeless tyres reduce the chances of getting punctured. Even if there is a puncture, sudden leakage of air is avoided, thereby provide better safety and convenience. It is also very easy to repair the punctured tyres.



\*\* Applicable only for drum brake version

### LED HEAD LAMP

Your Scooter comes in with a premium LED head lamp. Efficient and bright, this gives TVS Jupiter ZX a totally upgraded Look and Style with better visibility for night rides.



### BACKREST PILLION HANDLE IN BLACK COLOUR\*

The cushioned pillion handle lets the pillion rider relax and enjoy the ride. The sturdy black grabrail provides additional support and complements the premium-ness of the scooter.



### DUAL COLOR SEAT

The dual colored seat stitched to perfection ensures not just a comfortable seating experience but lets you stay classy on the road.



### PATENTED E-Z CENTRE STAND

E-Z Centre Stand of your scooter reduces the effort required to place the scooter on stand. Refer page No. 65 for operating procedure.



*\* Applicable only for disc brake version*

### ALL BLACK LARGER ALLOY WHEELS

All 'Black Larger Alloy Wheels' with high mechanical advantage gives progressive braking of your scooter, results in best-in-class 'shortest distance' braking. It also provide superior comfort in bad road conditions.



### PARKING BRAKE (REAR BRAKE LOCK)

'Parking Brake' is another unique safety feature which protects your scooter from falling due to wheel rotation when it is parked with the side stand on a slope. Refer page No. 61 for details.



### DISC SYNCHRONISED BRAKE TECHNOLOGY (SBT)

Taking technological innovation to next level, your scooter comes with 'Synchronised Brake Technology (SBT)'. This feature enhances the safety by avoiding skidding during sudden braking.



## ACCESSORIES

### UNDER-SEAT STORAGE (UTILITY BOX)

Your scooter has a 21 litre under-seat storage space to carry your luggage belongings, full face helmet etc., refer page No. 68 for details.



### HELMET HOOKS

Your scooter has two helmet hooks under the seat assembly at the front end of utility box to secure your helmet. Refer page No. 69 for details.



### FRONT GLOVE BOX

TVS Jupiter ZX is provided with glove box front. Which has 1 litre storage capacity and used to hold your mobiles while charging or hold a small bottle.



### SMART PHONE CHARGER

Your TVS Jupiter ZX is provided with a socket for charging your smart phone even while you are traveling and it is located below the left side of the handle bar. Refer page No. 71 for usage details.



### ACCESSORIES FOR YOUR SCOOTER

#### UTILITY BOX LIGHT#

TVS Jupiter ZX has a 'Utility Box Light' which lights up the utility box automatically whenever the seat is open.



#### INDICATOR BEEPER#

Your scooter has an electronic beeper which alerts you that the turn signal indicators are 'ON'. This beeper comes as a mandatory accessory.

# Optional accessory will be charged extra



Dear **TVS Jupiter ZX** Owner,

Thank you for choosing **TVS Jupiter ZX**, a stylish scooter with an all-new CVT-i engine and many class-leading features. As the proud owner of a **TVS Jupiter ZX**, you are now a part of the family of millions of satisfied TVS customers.

**TVS Jupiter ZX** comes equipped with **ETFI (Eco Tuned Fuel Injection) BSVI technology**, giving you a smoother and enjoyable riding experience. With **TVS Jupiter ZX**, riding comfort enters a new dimension. This innovative mobility embodies a combination of class-leading features and style unprecedented in the two-wheeler segment. Its unique vehicle design and superior ergonomics make it a scooter which gives you more in every aspect.

This manual explains the features and operations of your **TVS Jupiter ZX**. Kindly read it carefully and follow the instructions to enjoy years of safe riding. To ensure reliable performance, we urge you to get your **TVS Jupiter ZX** serviced only at TVS Motor Company Authorised Main Dealer / Authorised Dealer at specified regular periodic intervals.

We welcome you once more to a world of comfortable and easy riding!

**TVS MOTOR COMPANY LIMITED**

Take time to familiarize yourself with your TVS Jupiter ZX and its performance characteristics.

This Owner's Manual contains a host of useful information. Please take the time to read this manual before you ride your new TVS Jupiter ZX. Get familiarised with the operation of your scooter for maximum safety and pleasure. The better you know your vehicle, the more pleasure you will experience riding your new vehicle. Ensure that anyone else riding your TVS Jupiter ZX does the same.

All information, illustrations, photographs and specifications contained in this owner's manual are based on the latest product information available at the time of this publication. TVS Motor Company Limited may, however, incorporate modifications or improvements on its vehicles at any time without notice, and therefore, in such events it is possible that the relevant part of the owner's manual does not apply to your vehicle.

Prior permission of TVS Motor Company Limited is required for quoting, copying or reproducing any part of this owner's manual.

### Note

*Accessories shown in the picture may not be part of the standard equipment. Pictures shown in this manual are of TVS Jupiter ZX Disc SmartXonnect model unless specified.*

*Your scooter is provided with always glowing head lamp (AHO). The head lamp glows automatically once the engine is started.*

*TVS Jupiter ZX Disc SmartXonnect is fitted with 'TVS intelliGO' which is an intelligent start/stop system that switches 'OFF / ON' the scooter automatically (Refer page No. 27 for further details)\*.*

***TVS Jupiter ZX Disc SmartXonnect has a provision to fit side stand# & side stand sensor#. Once the vehicle is fitted with side stand# & side stand sensor#, it enables engine cut-off when side stand is in open condition (for anti fall safety). Rider must ensure to close / retract the side stand before starting the vehicle.***

*\* Applicable only for disc brake version*

*# Side stand and side stand sensor are provided as accessory and will be charged extra*

Revision 6, As on 30 Jan 2024



Operating this vehicle safely is an important responsibility of the rider. To help you make decisions on safety, we have provided necessary operating procedure and other information in this manual. This information alerts you on potential hazards that could hurt you or others. Since it is not possible to warn you about all the hazards associated with operating or maintaining the vehicle, you must use your own judgment.

You will find important safety information in following form in this manual. These words carry the following connotations:

 **Warning**

*Disregarding this message might result in **injury to the rider or deadly accidents.***

 **Caution**

*This message indicates special procedures or precautions to be followed to **avoid damage to the vehicle.***

 **Note**

*This message provides further clarification for **clear understanding of any particular information.***

The first 1000 km is a crucial part of your scooter. Proper running-in operation during this period helps in ensuring a **maximum life** and **smooth performance** of your scooter.

The reliability and performance of your scooter depends on the special care and restraint exercised during the running-in period. It is especially important that you avoid operating the engine in high speed (RPM), which could expose the engine parts to excessive stress. Recommended speed during the running-in is:

**Maximum 50 km/h speed upto 1000 km** (vary the engine speed for better mating of parts).

**The first free service at 500 ~ 750 km is most important.** During running-in period all the engine components and other parts will have set in. All adjustments to be restored, all fasteners to be tightened. **Engine and Transmission oil to be replaced.** Timely performance of the first free service will ensure optimum service life and performance from the engine.



### Caution

*Replacing the engine and transmission oil during first service is most important for better life of engine. Always use TVS TRU4 SKUUTA (SAE 10W30 API-SL, JASO MB) oil for better performance and life.*



## SAFE RIDING RECOMMENDATIONS

Any two wheeler riding requires some precautions to be taken to ensure the safety of the rider, pillion rider and other road users. These precautions are:

### Familiarise yourself with new TVS Jupiter ZX

Riding skill and your mechanical knowledge form the foundation of safe riding practices. We suggest you to practice riding TVS Jupiter ZX in a low-traffic condition until you are thoroughly familiar with your vehicle and its controls. Remember practice makes you perfect.

### Riding apparel

Loose, fancy clothing can be uncomfortable and unsafe when riding a two-wheeler. Choose good quality two wheeler riding apparel.

### Know your limits

Ride within the boundaries of your own skill at all times. Knowing these limits and staying within them will help you avoid accidents.

### Warning

***Two wheeler safety starts with wearing a good quality helmet.*** One of the most serious injuries that can happen is a head injury. Always wear an ISI approved helmet that should fit your head comfortably and securely. You should also have good quality goggles to protect your eyes and help your vision.

*To prevent or minimize accident, never consume alcohol or drugs before or during the operation of your vehicle. Even minimal consumption of these will affect the rider's ability to control the vehicle.*

## Posture

Proper vehicle riding starts with proper posture.

1. Keep your elbows relaxed and flexible.
2. Sit and adjust yourself on seat so that arms and shoulders are relaxed.
3. Look widely instead of gazing at one point.

## Warning

**One-hand riding is dangerous.** *Keep both hands firmly on the handle bar and both feet securely on the floor board. Under no circumstances should both the hands be removed from the handle bar, as it is very dangerous.*

**Avoid use of mobile phones while riding as it could lead to fatal accident.**

*Slow down to a safe speed before negotiating a corner. If this is the first time that you are riding a vehicle of this type, we suggest that you practice on a safe, open area to become thoroughly familiar with the operation of the vehicle.*

## Cornering

When cornering, centrifugal force works in a direction perpendicular to the direction in which the vehicle is moving. Centrifugal force increases in proportion with speed and the radius of the corner.

During cornering, reduce speed so as to lessen the effects of centrifugal force. By all means, avoid abrupt application of brake or sudden steering.

## Braking

For safe riding, it is very important to master the braking techniques.

1. Close / release the throttle.
2. Hold the vehicle upright as you apply the brake.
3. Progressive application of brake is safer.
4. Apply both the brakes. 'SBT' provides additional braking even when 'only rear brake' is applied, But applying 'both the brakes' helps you to use the full potential of the brakes.
5. Riding down hills, while cornering and wet roads, close throttle and come to a slower speed to avoid the loss of control over the vehicle due to skidding.

## Causes for poor braking

1. If the brake shoes / pads or drum / disc are worn out or if there is water or oil on them, sufficient friction does not develop and brakes do not work well.
2. Even when the brake works normally, if the road surface is wet or the tyre surface is worn-out, tyres do not take a firm hold on the surface, increasing the stopping distance.
3. Approximately 60% braking effect is from front brake. **Non-usage of front brake causes poor braking.**

### Warning

*As the vehicle speed increases, the stopping distance also increases progressively. Be sure that, you have sufficient distance between you and the vehicle or obstruction ahead of you.*

*Using only the front or rear brake is dangerous and can cause skidding and loss of control. **Apply both the brakes together and with great care on a wet road or other slippery surfaces.** Any abrupt braking on slippery or irregular roads can cause loss of rider control.*

## ACCESSORY INSTALLATION AND SAFETY TIPS

Use extreme caution while selecting and installing the accessories for your scooter.

The addition of **unsuitable accessories can lead to unsafe operating conditions.** Your friendly Dealer will assist you in selecting quality accessories and installing them correctly.

While selecting the accessories, make sure that the accessories **should not obstruct lighting, steering, suspension level and ground clearance.**

**Additional electrical equipments is not acceptable as it will void warranty terms of the vehicle.**

## EMISSION CONTROL

All the TVS vehicles are tested in the factory for optimum fuel efficiency and CO levels. If the vehicle needs any adjustments, please consult nearest TVS Motor Company Authorised Main Dealer or Authorised Dealer.

While adequate care is exercised at the factory to ensure that the emissions are within the limits, it is essential for the owner to always maintain the scooter in good condition by getting it periodically checked and serviced by TVS Motor Company Authorised Main Dealer / Authorised Dealer so that the emission and fuel consumption levels are maintained as per norms.

### Crankcase emission control system

The engine of new TVS Jupiter ZX is equipped with a closed crankcase system to prevent discharging crankcase emissions into the atmosphere. Blow-by gas is returned to the combustion chamber through the air cleaner and the fuel system.

### Evaporative emission control system

TVS Jupiter ZX is equipped with an evaporative emission control system which consists of a canister and associated piping. This system prevents the escape of fuel vapors from the fuel tank.

### Warning

*If there is any abnormal jerk, startability issue are felt in the vehicle or noise due to sudden escape of gas during opening of fuel tank cap, immediately report to the TVS Motor Company Authorised Main Dealer / Authorised Dealer.*

### Note

***Your vehicle is tested and certified for emission which meets BS VI emission norms and is valid for initial 12 months from the date of purchase. Get your vehicle certified by the Government authorised emission testing station after initial 12 months of usage. And ensure to get the vehicle certified on expiry of the certificate obtained.***



**VEHICLE IDENTIFICATION NUMBER**

The frame and engine serial numbers are the only means of identifying your vehicle from others of the same model and type. They are also required to assist your Dealer for ordering parts or referring to special information.



The frame serial number is stamped on the frame, at the rear end below the seat assembly. Open the seat assembly to read the frame number.



The engine serial number is stamped on the left side of the engine, at the bottom, near center stand mounting. See bottom to read serial number.

## LOCATION OF PARTS - HANDLE BAR



1. Connected instrument cluster
2. Rear view mirror R
3. 'TVS IntelliGO' switch\* / Engine kill switch\*\*
4. Right hand brake lever
5. Throttle grip
6. Voice assist switch
7. Electric starter switch
8. All in one lock
9. Bag hook (front)
10. Glove box
11. Smart phone charger#
12. Horn switch
13. Turn signal lamp switch
14. Left hand brake lever
15. Parking brake (rear brake lock)
16. Rear view mirror L
17. High / low beam cum pass-by switch

\* IntelliGO switch is applicable only for disc brake version

\*\* Engine kill switch is applicable only for drum brake version

## LOCATION OF PARTS - VEHICLE LEFT SIDE



1. Rear brake adjusting nut
2. Kickstarter lever
3. Effortless easy center stand
4. Side stand<sup>#</sup> & side stand sensor<sup>#</sup>
5. Pillion foot rest L
6. Caliper assembly front
7. Disc plate front
8. Backrest pillion handle<sup>\*</sup>

*\* Applicable only for disc brake version*

*<sup>#</sup> Side stand and side stand sensor are provided as accessory and will be charged extra*

## LOCATION OF PARTS - VEHICLE RIGHT SIDE



1. Front wheel axle nut
2. Bag hook (rear)
3. Cover front
4. Pillion foot rest R
5. Gauge oil level
6. Muffler assembly
7. Rear fender
8. Seat assembly

## LOCATION OF PARTS - VEHICLE FRONT & REAR

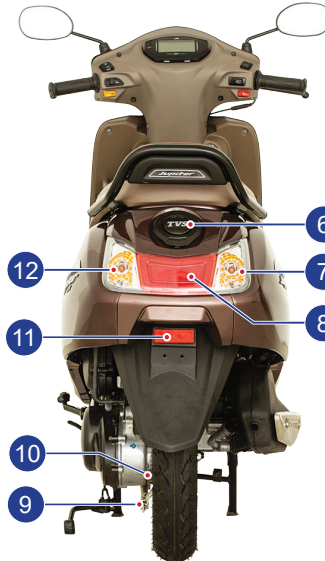
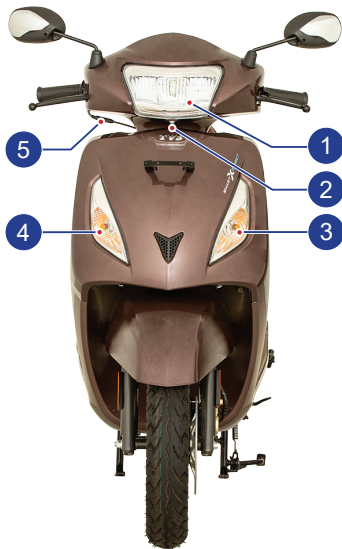

### FRONT

1. LED Head lamp
2. Head lamp focus adjuster
3. Turn signal lamp front LH
4. Turn signal lamp front RH
5. Throttle cable adjuster

### REAR

6. Fuel tank cap
7. Turn signal lamp rear RH
8. Tail / brake lamp
9. Rear brake adjuster
10. Transmission oil level screw
11. Reflex reflector
12. Turn signal lamp rear LH

# License plates are mandatory accessory will be charged extra

## ALL IN ONE LOCK

TVS Jupiter ZX comes with an 'all in one lock'. It has five positions and they are:

### 1. 'OFF' position

All the electrical circuits are turned 'OFF' in this position. Engine will not start. Key can be taken out.

### 2. 'ON' position

In this position, all the electrical circuits are turned 'ON' and the engine can be started now. Key cannot be removed in this position.

### 3. 'LOCK' position

TVS Jupiter ZX steering can be locked in both 'left' and 'right' directions.



To lock the steering, turn the handle bar all the way to the 'left' or 'right'. Push the key 'IN', turn it to the 'LOCK' position and take out. All the electrical circuits are turned 'OFF' in this position. **Insert the key into the lock and turn it to 'OFF' or 'ON' position to unlock the steering.**

### Note

*When you switch on the ignition key, the pump priming noise may be heard, which is normal. Avoid frequent 'SWITCH -OFF & ON' of ignition key, to avoid unnecessary run of fuel pump.*

*The speedometer back illumination, tail lamp and license plate lamp glow automatically once the ignition key is turned 'ON' without activating any other switches.*

### Caution

*Leaving the ignition cum steering lock in 'ON' position will drain the battery when the vehicle is not in use. 'Switch off' and take the key out when the vehicle is not in use. For safety always lock the steering while parking.*

### Warning

*Never attempt to move the vehicle when the steering is locked, you may lose balance.*

#### 4. 'Seat unlock' position

Seat lock is inbuilt in 'all in one lock' of TVS Jupiter ZX. To open the seat, keep the key in 'OFF' position and turn it to anticlockwise direction without pushing the key 'IN'.

To lock the seat again, press the seat at the rear end to its position. Ensure the locking of seat by hearing 'Click' sound.

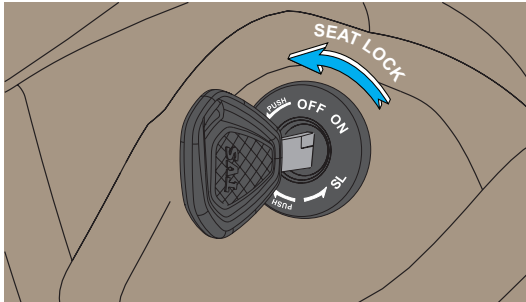

#### 5. 'Fuel tank cap unlock' position

Fuel tank cap lock is inbuilt in 'all in one lock' of TVS Jupiter ZX. To open the fuel tank cap, keep the key in 'OFF' position, push the key 'IN' and turn it to clockwise direction. The tank cap opens automatically.

To close the fuel tank cap, press the cap at the front end to its position until a 'Click' sound is heard.

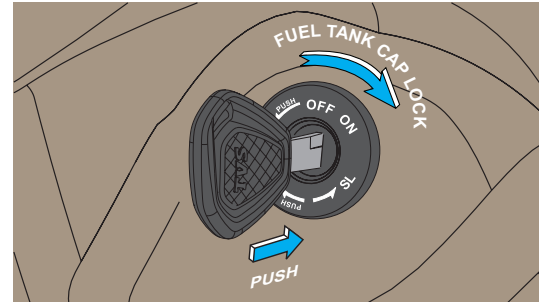

## CONNECTED INSTRUMENT CLUSTER

Your TVS Jupiter ZX is provided with a fully digital connected instrument cluster with lots of features. The connected instrument cluster also has a mobile app for 'Smart Phones' and navigation assist etc. additionally along with other features.



### 1. ISG malfunction indicator ( )\*

ISG malfunction indicator will be turned 'ON' when the ISG detects a fault in the system.

If the ISG malfunction indicator is glowing after the self check of the speedometer, immediately contact the nearest TVS Motor Company Authorised Main Dealer or Authorised Dealer.

### 2. Economy and power indicator

Eco indicator (green lamp) indicates that the vehicle is running in economy mode which gives better fuel economy.

Power indicator (amber lamp) indicates that the vehicle is running in power mode which results in reduced fuel economy.

### Note

*Always ride the vehicle in 'economy mode' for better fuel efficiency.*

*If the battery voltage is very low, power mode lamp will glow once you switch 'ON' the ignition key till you start the vehicle. Electric starter will not work in this condition. Use kick starter only. Contact TVS Motor Company Authorised Main Dealer or Authorised Dealer.*

\* Applicable only for disc brake version



### 3. 'TVS intelliGO' indicator\*

Fuel is consumed unnecessarily when the engine is in idling (e.g. In traffic signals) as there is no useful output to the wheel. It contributes to emission and decreases mileage of the vehicle considerably.

To overcome this issue 'TVS intelliGO' system is introduced in TVS Jupiter ZX to automatically shut down the engine when it is kept idling for long and restart from stop condition by simply pressing the Brake and giving Throttle. The vehicle also can be restarted using 'Electric start' or 'Kick start' if required.

**Use of this 'TVS intelliGO' system improves the fuel economy and reduces emission.**

#### Activation of 'TVS intelliGO' system:

'TVS intelliGO' system gets activated when the following requirements are satisfied,

1. 'TVS intelliGO' switch is in '  ' position
2. Engine is warmed up and
3. When the vehicle speed is more than 5 kmph

When the vehicle met the above conditions, the 'TVS intelliGO' system gets enabled and the intelliGO indicator '  ' in the speedometer glows and informs you that the vehicle has entered the intelliGO loop and the engine will stop automatically at upcoming vehicle idling condition (Idle start stop).

Once the vehicle enters the idling condition, the intelliGO indicator starts blinking instead of glowing and engine stops after predetermined time.

The intelliGO indicator again start to glow during the engine stop to indicate you that the vehicle has stopped by the 'intelliGO' system.

The head lamp brightness will be reduced to 50% after 30 seconds from the engine stop by 'intelliGO' system to improve the battery life and to avoid battery drain. All other DC system will work normally. After 4 mins of vehicle stop, the head lamp will get 'OFF' completely. This is an indication that the restart of vehicle from stop condition by applying Brake and Throttle is about to be deactivated.

**The vehicle stopped by 'TVS intelliGO' system can be restarted at any time within 5 mins from the stop of the vehicle by intelliGO feature in a simple way of applying Brake and Throttle.**

#### Deactivation of 'intelliGO' system:

- 'Idle start stop' system will be deactivated if the intelliGO switch is positioned at '  ' position.

*\* Applicable only for disc brake version*

- If the ISG malfunction indicator or MIL indicator is 'ON' then the intelliGO system will not get activated.
- If there is 5 unsuccessful start of the vehicle either by electric start or by intelliGO restart method in one ignition key 'ON' cycle then the intelliGO will not get activated.
- If vehicle is not restarted within 5 mins from idle stop, then intelliGO will be deactivated.

#### **Prolonged idling:**

When vehicle is in idling with the engine temperature high enough to maintain stable engine idling rpm and the intelliGO switch is in '  ' position, then the intelliGO will be activated.

When 'TVS intelliGO' is enabled, the intelliGO lamp glows for 5 seconds and then blinks for predetermined time and then the engine stops.

intelliGO lamp will glow after vehicle has stopped due to this feature. By applying Brake and Throttle the engine can be restarted again.

#### **Note**

*Ensure that the brake free play is adjusted and it is within the limit for the proper working of 'TVS intelliGO' system.*

#### **Note**

*Vehicle can be started at any point of time using 'electric start' or 'kick start' when the engine is stall condition and the ignition key in 'ON' condition.*

*'TVS intelliGO' switch can be activated / deactivated at any point of time.*

*If vehicle is stopped by 'TVS intelliGO' system, and the 'TVS intelliGO' switch is toggled from 'ON' to 'OFF' and back to 'ON', the intelliGO system will be deactivated and the vehicle can be restarted only by the 'electric start' or using 'kick start'.*

#### **4. High beam indicator lamp ( )**

Glows when the head lamp is activated in high beam or pass-by condition.

#### **5. Turn signal indicator left ( )**

Flashes when the 'left' side turn signal indication is activated.

#### **6. Turn signal indicator right ( )**

Flashes when the 'right' side turn signal indication is activated.

## 7. Low fuel indication ( )##

The low fuel indicator glows when the fuel in the tank reaches to empty level, and a message 'FUEL EMPTY' will be displayed at alpha numeric display of the instrument cluster.

FUEL EMPTY



### Caution

*When the low fuel warning indicator lamp glows, fill the fuel immediately to avoid engine switch 'OFF' / damage to fuel pump which leads to replacement of fuel pump without warranty.*

## 8. Malfunction indicator lamp - MIL ( )

MIL will be turned ON when the ECU detects a fault in the system and MIL will blink when the ECU detects a misfire in the engine.

**If the malfunction indicator lamp '  ' is glowing continuously or blinking continuously when the engine is started, immediately contact the nearest TVS Motor Company Authorised Main Dealer or Authorised Dealer.**

## Note

*The malfunction indicator will continue to remain switched 'ON' after self checking of cluster until the engine is started. But after starting the engine it will get switch 'OFF' if there is no malfunction is detected in the system.*

## 9. Alpha numeric display

The customized alpha-numeric display indicates the vehicle information and Smart-connect related messages, when the ignition key is turned 'ON'.

*## 'LFI' is not a mileage calculating medium and it should not be used for measurement of fuel consumption*

The following features will be displayed on the connected instrument cluster:

- a. Odometer
- b. Digital clock
- c. Fuel gauge
- d. Speedometer
- e. Engine temperature gauge
- f. Helmet icon
- g. Low battery indicator
- h. Service reminder
- k. Trip A, B and F
- m. Side stand indicator

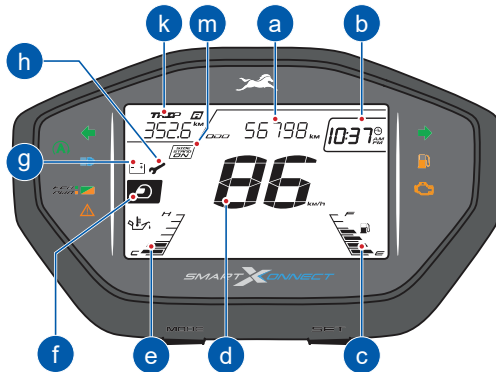

### Note

The connected instrument cluster of your scooter enters into BT pair mode automatically, when the following conditions are met:

1. Battery is disconnected and reconnected again.
2. When the vehicle fuse is blown and replaced.
3. When the electric start is done with the low SOC (state of charge) battery (will be indicated through self-check of connected instrument cluster).

### a. Odometer

Odometer registers the total distance covered by the vehicle in kilometer.



### b. Digital clock

Indicates the time in 12 hour format (AM or PM).



### Note

*If the battery is disconnected and reconnected during service, you may need to reset the time as explained in page no. 43.*

*Otherwise the clock timing will be set automatically as per the connected mobile device after completion of successful Bluetooth pairing when auto sync clock is enabled in App.*

### c. Fuel gauge

Digital bars indicates the approximate quantity of fuel available in the fuel tank. There are six bars to indicate the quantity of fuel available in the tank.



All the six bars will be displayed when the fuel in the tank reaches above 5 liters approximately (full tank). When the fuel reaches half tank (3.2 liters approx.) the fuel gauge displays only three bars as shown.



When the fuel reaches minimum safe level (1.2 liters approx.), the last bar of the fuel gauge starts blinking and low fuel indicator starts glowing. The message 'FUEL EMPTY' will be displayed at alpha numeric display and 'TRIP F' meter starts counting from 0.0 km as explained in page no. 34.



### Note

If all the fuel level bars of the connected instrument cluster are blinking and an error message 'CHECK FUEL SENSOR' displayed at alpha numeric display as shown, Contact nearest TVS Motor Company Authorised Main Dealer / Authorised Dealer.



### Note

Please note that, the fuel gauge is not a mileage calculating medium and it should not be used for calculating the mileage.

### d. Speedometer

Indicates the vehicle speed in kilometer per hour by default when the ignition is turned ON.



### e. Engine temperature gauge

The temperature gauge displays the engine temperature in digital bars. There are six bars to indicate the engine temperature. All the six bars will be displayed if the engine temperature raises beyond normal operating temperature and a diagnostic message 'ENGINE WARNING' also will be displayed at the alpha numeric display as shown.



On occurrence of the above error message, the vehicle should be kept in idling for 10 minutes approx. and switch 'OFF' the vehicle. If the problem continues even after cooling the engine, take the vehicle to TVS Motor Company Authorised Main Dealer or Authorised Dealer and get it rectified.

#### f. Helmet icon

With every ignition 'ON', Helmet icon '' blinks for 10 seconds on the left side of the connected instrument cluster to remind the rider to wear a helmet.

#### g. Low battery indicator

An icon with battery symbol '' glows when the battery charge is too low. Get the battery checked at TVS Motor Company Authorised Main Dealer / Authorised Dealer.



#### Caution

*Startability of vehicle using electric start will be difficult when the low battery indication is 'ON'. intelliGO feature will be disabled.*

#### h. Service reminder

If the service is due, whenever the ignition is turned 'ON', a icon with spanner symbol '' blinks for 10 seconds after the self-check cycle of connected instrument cluster and continue to glow till the vehicle is serviced and the reminder is reset. Get the vehicle serviced at TVS Motor Company Authorised Main Dealer / Authorised Dealer.

#### Note

*Service reminder indicator lamp works only based on the distance (km) covered by the vehicle. This is only a reminder indicator. Customers are advised to keep track and follow the service schedule.*

### k. Trip A and B

Trip meter indicates the trip distance traveled in kilometer. The digit after the dot mark denotes one tenth of a kilometer.



Provision is provided for the users to measure two different distances as per their convenience.

'TRIP A' will be displayed by default. Press mode button once to enter 'TRIP B'. To reset any of the trips (A or B), press the 'SET' button more than 5 seconds while display is in the respective trip mode when vehicle is in static condition.

### Trip F



This function shows the distance traveled after the low fuel indication symbol (  ) is 'ON' and 'FUEL EMPTY' message displayed at alpha numeric display. The display switches automatically to 'TRIP F' once the low fuel indication is 'ON' and starts counting from 0.0 km.

If the fuel level remains in minimum safe (reserve) level, the reading will be saved even after the ignition 'OFF'.

The 'TRIP F' meter stops counting and gets cleared automatically once the fuel is filled above minimum safe (reserve) level which is indicated by at-least 2 bars in the fuel gauge. Once 'TRIP F' is cleared, 'Trip A / B' display switches 'ON' automatically.

**Please remember that the 'TRIP F' meter cannot be activated or deactivated manually and can't be reset.**

On every ignition 'ON', 'TRIP F' meter will get enabled automatically until fuel level raises above minimum safe level. 'TRIP A' and 'TRIP B' will still be accessed by short pressing the 'Mode' switch but the display will automatically enter 'TRIP F' after 5 seconds.



### m. Side stand indicator

The side stand warning indicator will blink to alert you whenever the vehicle's side stand is deployed (vehicle parked condition).



### Note

*If the side stand<sup>#</sup> is deployed the vehicle will not start. Retract the side stand to start the vehicle.*

*When there is a failure in the side stand sensor, in stand deployed condition the vehicle will not stop. As a safety measure it is recommended to visit the nearest TVS Motor Company Authorised Main Dealer / Authorised Dealer to get it rectified.*

*<sup>#</sup> Side stand and side stand sensor are provided as accessory and will be charged extra*

## MODE AND SET BUTTONS

The Mode and Set buttons are provided to change between various 'TRIP' modes and to set the some of the digital display functions of the instrument cluster. The sequence of modes and their selections are explained in detail below.



### Note

The above mode changes are possible only when the vehicle is in static for safety.

Short press the Mode button to access the following modes:

1. Trip A
2. Trip B
3. Trip F\*

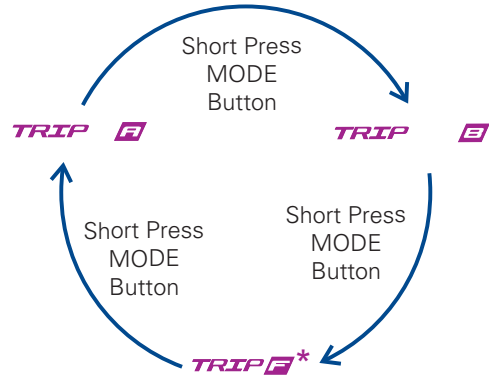

### Resetting Trip A and B

Press the 'Mode' switch once or twice to change the display to 'TRIP A' or 'TRIP B' mode which needs to be reset. Now press the 'Set' switch for 5 seconds to reset the respective trip data.

\* 'TRIP F' can be accessed incase of low fuel only.

On long pressing the Mode button, the following modes can be accessed.

1. Bluetooth pairing mode
2. Set clock

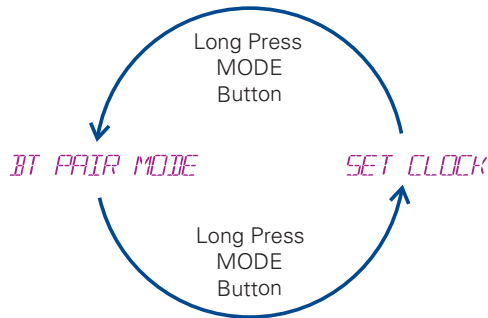

### BT pair mode

This mode can be entered by pressing 'MODE' button for 5 secs.

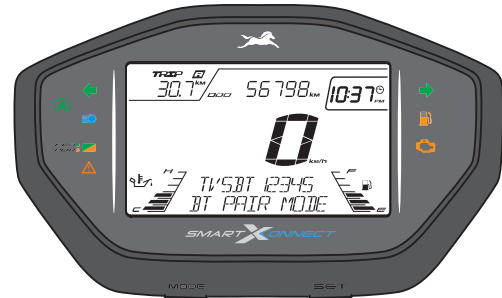

The connected instrument cluster of your TVS Jupiter ZX can be connected to your Android™ smart phones and iPhone® via Bluetooth® through a **TVS CONNECT** app which can be downloaded from Google Play and the App Store®.



**TVS CONNECT**

## Note

*In this mode, if the vehicle speed crosses above 2 km/h, the connected instrument cluster will enter to 'TRIP A' mode automatically.*

*Any number of Android phones can be auto-paired with the instrument cluster.*

*Only one iPhone can be auto-paired with a single instrument cluster at a time. If the user need to connect multiple iPhones with the single instrument cluster, the previous connected iPhone has to be forgotten by clicking, "Forget This Device" from Bluetooth settings in the iPhone.*

*If the vehicle battery is reset or fuse is blown, then too "Forget This Device" from Bluetooth settings in the phone has to be done.*

Steps to "Forget This Device" in iPhone:

If the user needs to connect multiple iPhones with the single instrument cluster, the previous iPhone has to be forgotten using "Forget This Device" from Bluetooth settings in the following manner:

1. In the previous connected iPhone, open the SETTINGS -> BLUETOOTH.

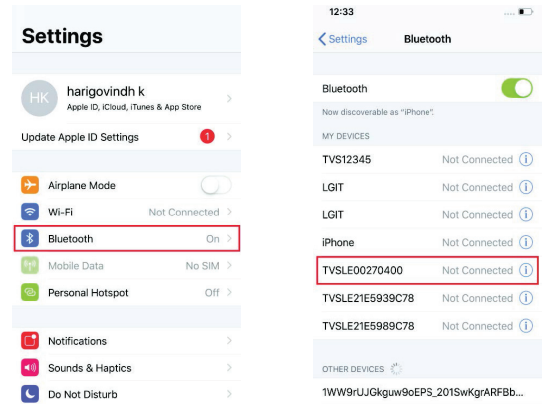

2. Select the instrument cluster, which was connected previously.
3. Click on the "Forget this device".

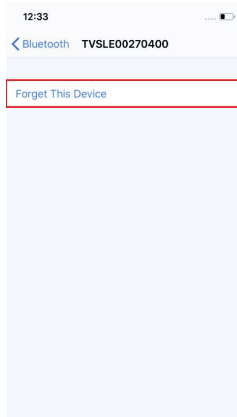

### First time Bluetooth pairing:

To pair your Android smart phone or iPhone with your TVS Jupiter ZX's connected instrument cluster, via Bluetooth, for the first time, follow the procedure as described below :

1. Switch 'ON' the vehicle.
2. Speedometer can be in any mode for first time pairing.
3. Open the app and press "**CONNECT**", ensure the smart phone is near to the vehicle.
4. The app searches for all Bluetooth devices nearby and displays the list of devices available.

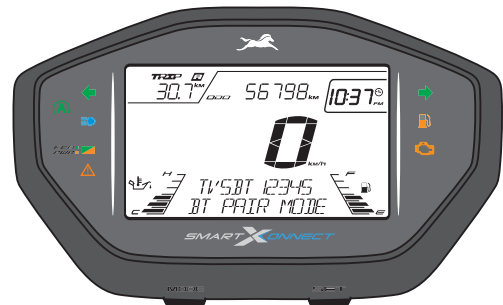

- The connected instrument cluster's Bluetooth name is prefixed by TVSBT and followed by alpha-numeric digits. Ex : 'TVSBT12345'. This Bluetooth name can be found by changing the cluster mode into BT pair mode.
- Now, select the 'TVSBT12345' in app to initiate the pairing process.
- On pairing, the alpha-numeric display of connected instrument cluster displays 'CONNECTION SUCCESSFUL' message for 3 secs and a Bluetooth icon '  ' will be displayed on the speedometer. Additionally phone's battery icon and signal strength icon will be displayed on connected instrument cluster.

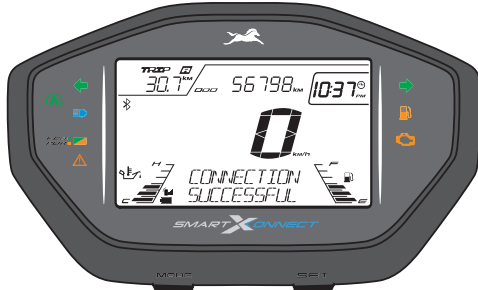

- For initiating first time pairing, logout from the app, login again using your login credentials and then press CONNECT.

### Note

*During the course of pairing process, if there is any occurrence of error, the connected instrument cluster should be turned 'OFF' and 'ON', and the application also need to be restarted.*

*Please remember that, all the smart phones are not compatible for pairing with the TVS Jupiter ZX's connected instrument cluster.*

*During the search of Bluetooth devices in app, if the vehicle's connected instrument cluster Bluetooth device ID is not visible, try for one or two more iterations.*

## Auto pairing

Once the first time pairing is done between vehicle's instrument cluster and your smart phone, the phone will automatically pair with the vehicle when the following conditions are met :

1. Vehicle is switched 'ON' and vehicle is near to the smart phone.
2. Smart phone's Bluetooth is turned 'ON'
3. First time pairing is ensured.
4. In case of iPhone, the TVS CONNECT app should be open or be open in background for auto-pairing to happen.

While auto-pairing happens every time, the app will open automatically and connect with the Instrument cluster. The connected instrument cluster shows 'CONNECTION SUCCESSFUL' message as shown.

CONNECTION  
SUCCESSFUL

If your smart phone is disconnected from the vehicle's instrument cluster then a message will be displayed on the alpha-numeric display of connected instrument cluster as shown below example.

JOHN  
DISCONNECTED

## Note

*If the phone enters battery saver mode, auto-pairing might not happen. It takes maximum of five minutes for auto-pairing and it can happen in vehicle running or engine at idling or engine off condition.*

*Auto-pairing happens only if the application is locked in the RAM in multitasking screen of the phone with manufacture's customized OS (Ex : MI, Vivo etc.)*

*In case of Android phones with Android OS version above 8.0, for App to work seamlessly, any battery optimization setting to be removed in the TVS Connect App and GPS shall be allowed to run in background in high accuracy mode.*

*Even if your phone's Bluetooth is already paired to other gadgets like smart watch, health band or helmet, the auto-pairing works with your TVS Jupiter ZX's connected instrument cluster.*

*If the application unfortunately stops due to unforeseen circumstances, close and reopen the application and do the manual pairing for the first time, then auto pairing will happen subsequently.*

*For first time pairing, logout from the app, login again with your login credential and press CONNECT button.*

Once the connected instrument cluster of your TVS Jupiter ZX is connected with your smart phone, the connected instrument cluster displays Bluetooth '📶' icon, your mobiles battery level '🔋' icon and network providers signal strength '📶' icon.

### Note

*Incase multiple SIM cards are used in smart phone, by default, SIM 1's network provider's signal strength is shown in the display of connected instrument cluster.*

*Signal strength displayed in connected instrument cluster might vary from the display in smart phone as the former is referred from telephonic standards.*

Incoming call alert display '📞'

The connected instrument cluster will display the incoming calls alerts from the smart phone via Bluetooth. Ex. 'CALL FROM AMIT', will be displayed if the contact is stored in the smart phone's otherwise number will be displayed. Ex. 'CALL FROM 9863571861'. The smart-connect notification LED (green LED) starts blinking on receiving the incoming call till the call is active.

CALL FROM      CALL FROM  
AMIT              9863571861

Missed call alert display '📞'

The connected instrument cluster displays the total number of missed calls from the smart phone via Bluetooth 10 seconds approx., Ex. '3 MISSED CALLS'.

📞      03  
MISSED CALLS



## Note

Number of missed calls (inclusive of user rejected calls) will be displayed at the end of each incoming call and it will be reset once a trip is completed and a trip report is generated in app or if app is closed.

SMS alert display '✉'

The connected instrument cluster displays the incoming SMS from the smart phone via Bluetooth Ex. 'SMS FROM AMIT'. The sender name of the incoming SMS will be displayed in the connected instrument cluster only if the number is stored in the contact list of the smart phone.

✉ SMS FROM  
AMIT

## Note

The SmartXconnect Notification LED (green LED) blinks for five seconds approximately whenever there is a incoming message.

SMS alert display is not applicable for iPhones.

## Set clock mode

To enter the set clock mode, press 'Mode' button for more then 5 secs in Bluetooth pairing mode. The digital clock starts blinking once the connected instrument cluster enters the set clock mode.

- The hour digits of clock starts blinking and enables you to change the hours.
- Press the 'Mode' button to increase the hours while hour digits are blinking.
- On pressing the 'Set' button again the hours gets set and the minute digits starts blinking.

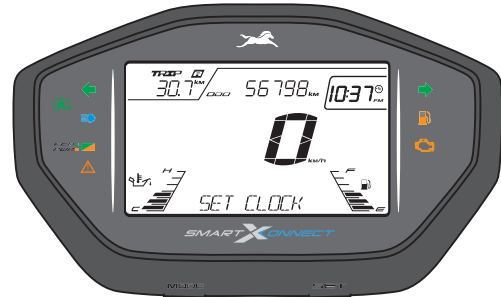

- Now, press the 'Mode' button to increase the minutes while minute digits are blinking.
- Once again press the 'Set' button so the minutes of the clock is set and the hours format 'AM' or 'PM' starts blinking.
- Press the 'Mode' button to change the hour format either to set 'AM' or 'PM'.
- Press the 'Set' button once again to set clock and wait for 5 secs to come out of set clock mode.

### Note

*If no input is given for more than 5 secs while the set clock mode is in operation, the connected instrument cluster comes out of this mode automatically.*

*The clock time gets sync automatically on pairing your Android smart phone with the connected instrument cluster provided if auto sync clock setting is enabled in app.*

### TVS CONNECT APP



Dedicated smart phone app is available in the Google Play and the Apple store for your 'TVS Jupiter ZX' and it can be installed in your Android and Apple smart phones. To access the features of your TVS Jupiter ZX's connected instrument cluster like :

- Incoming call alerts in connected instrument cluster.
- Incoming SMS alerts in connected instrument cluster (applicable only for Android smart phones).
- Number of missed call alerts in connected instrument cluster.
- Battery status of your smart phone in connected instrument cluster.
- To send auto reply SMS to the callers via smart phone (applicable only for Android smart phones).
- "Do Not Disturb" mode during the ride (applicable only for Android smart phones).



- To send navigational assist instructions inputs to the connected instrument cluster from your smart phone.
- To save the last traveled route.
- To locate the last parked location of your TVS Jupiter ZX.
- To know the signal strength of your mobile network in connected instrument cluster.
- To generate and store Ride reports.
- To sync the connected instrument cluster clock with smart phone clock.
- To control the background illumination of the Instrument cluster.

This dedicated mobile app of your TVS Jupiter ZX can be downloaded from the Google Play and the App Store® by searching the key word '**TVS CONNECT**' else by scanning the below QR code.



*Android*



*iOS*

### **Note**

*This smart phone app is compatible only for the smart phones with Android OS version Kitkat (4.4) and above, iOS version 9 and above and the BLUETOOTH version 4.0 and above. Android and Google Play are trademarks of Google LLC. App Store® and iOS are trademark of Apple.*

## How to login

On opening the **TVS CONNECT** app the following introductory screens will be displayed.

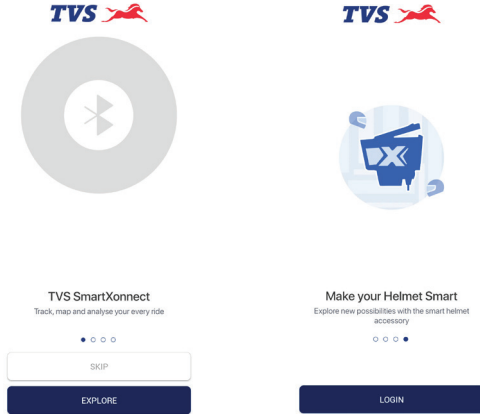

Move to the last screen or press the 'EXPLORE' tab until the last screen is reached where you will find the 'LOGIN' tab.

On clicking on the login, you will come to the login screen, and you need to enter the 10-digit mobile number.

## Note

*Incase if the mobile number is already registered, you can click on 'SKIP' tab to go the login screen directly.*

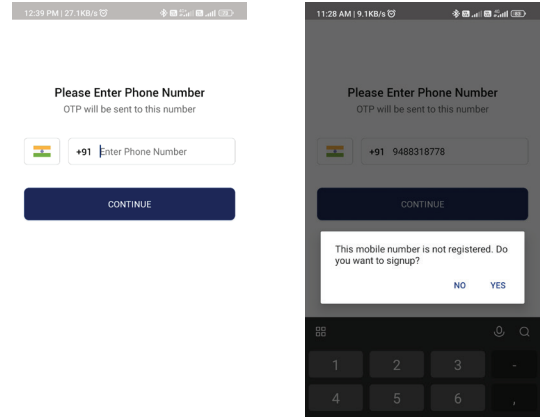

After entering the mobile number, if the mobile number is not already registered then you to click on 'Yes' for sign-up process or press 'No' to cancel the sign-up process.

On clicking of 'Yes', you need to provide the below details,

- ◆ Full name
- ◆ Email id
- ◆ City

and click on Terms of use and Privacy policy. Finally, click the 'SUBMIT' tab after verifying your data.

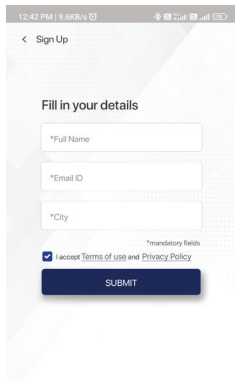

The screenshot shows a mobile application interface for signing up. At the top, it says "Sign Up" with a back arrow. Below that, there's a section titled "Fill in your details" with three input fields: "\*Full Name", "\*Email ID", and "\*City". A small note indicates that these are mandatory fields. Below the fields is a checkbox labeled "I accept Terms of use and Privacy Policy", which is checked. At the bottom, there is a dark blue "SUBMIT" button.

On submitting the details a screen opens with one time password (OTP) entry.

Enter the OTP which is received from TVS Motor Company Limited and continue.

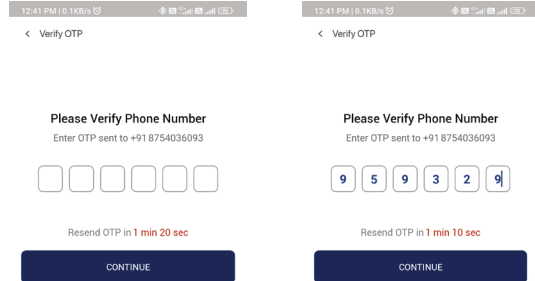

The first screenshot shows the "Verify OTP" screen. It has a back arrow and the text "Verify OTP". Below that, it says "Please Verify Phone Number" and "Enter OTP sent to +91 8754036093". There are six empty input boxes for the OTP. Below the boxes, it says "Resend OTP in 1 min 20 sec" and a dark blue "CONTINUE" button.

The second screenshot shows the "Verify OTP" screen with the OTP "959329" entered in the input boxes. The "Resend OTP in 1 min 10 sec" timer is visible, and the "CONTINUE" button is still present.

### Note

*If your mobile number is registered already and you want to login, skip the initial screens and enter the mobile number in the login screen. Key-in, paste, or auto fetch the OTP received to directly enter the home screen.*

On submitting the OTP, another screen opens where you will be asked to enter emergency contact numbers.

You can add the emergency numbers by clicking the 'ADD EMERGENCY CONTACTS' tab if required or else skip the step by closing the screen.

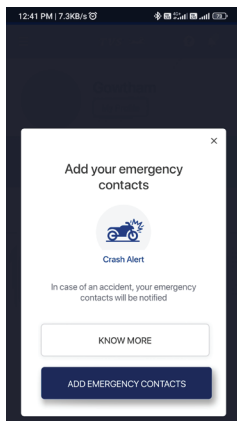

Either after entering the emergency contact details or else after skipping the procedure another screen opens and ask you accept the terms and conditions. Accept the terms to continue.

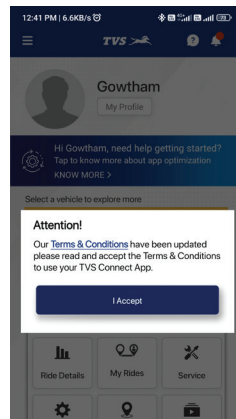

### Note

*Please remember that the Navigation License has to be renewed after 5 years of vehicle purchase and renewal can be done by contacting near by Dealer end.*

## Add vehicle

Add vehicle tab allows you to add any of your TVS bikes by entering its chassis number. You can have sample view of the frame number.

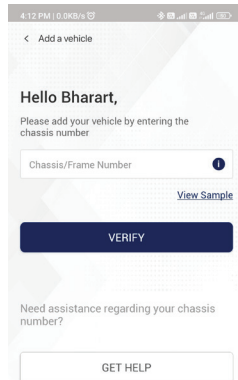
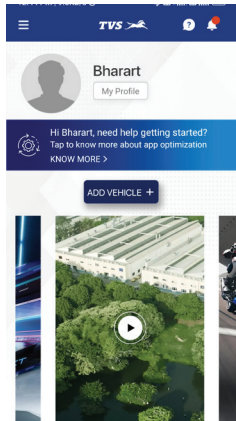

Incase you need any assistance regarding your vehicle's chassis number press the 'GET HELP' tab and enter the particulars. You can get the number by chatting with us or by E-mailing to us or by calling us.

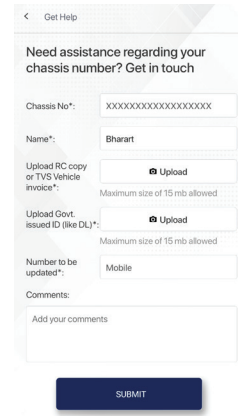

## Voice assist

A dedicated voice assist switch is provided in your TVS Jupiter ZX vehicle to invoke voice assistant. Once, the mobile app is connected to the speedometer.

There are two ways to invoke voice assist in your scooter:

1. By pressing the Voice assist switch\* for 1 or less than 1 second.
2. By pressing the voice assist icon in the app live dashboard (shown in the image).

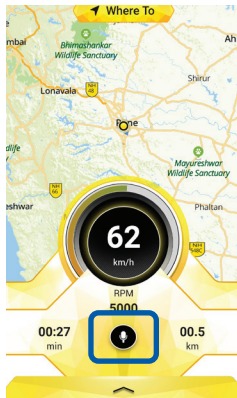

## Note

*Voice assist will work with screen lock condition / app background condition.*

*Use Wired / Wireless headphone for listening and talking.*

*Voice feedback will work only if a wired / wireless headphone is connected.*

*Option to enable/disable voice assistant and voice feedback is available in App settings.*

After invoking voice assist through either of the two ways, "Listening" will appear on the screen and speak now will be heard on the headset.

This is when we have to start speaking / providing the command.



The following are the list of intents recognized by voice assist. You can refer page no. 52 for sample commands of each intent.

- Greeting command
- Navigation command
- Nearest POI command
- Brightness increase / decrease command
- Current location
- Missed call
- Last call
- Top speed
- Enable / Disable Auto SMS
- Enable / Disable Do Not Disturb
- Enable / Disable High Speed Alert
- Volume increase / decrease

## Voice assist commands and key words

S. No.	Intent	Commands	Voice Feedback
1	GREETING	Hi buddie	Hello ' ____ '
		How are you doing	
		Hi buddie	
		Hey buddie	
		Hello friend	
		How u doing	
2	NAVIGATION	Go to	Taking you to ' ____ '
		Take me to	
		Let's go to	
		Navigate to	
		Navigate me to	
		Guide me to	
		Show me	
		Take to	
		Directions to	
		Show me Directions to	

S. No.	Intent	Commands	Voice Feedback
3	POI	Near	Taking you to nearest '____'
		Near by	
		Near to	
		Nearest	
4	BRIGHTNESS INCREASE	Brightness Increase	Brightness increased
		Brightness Up	
		Brightness High	
		Increase the speedo brightness	
		Turn up the brightness	
		Turn off night mode	
		Increase the brightness	
Increase speedo brightness			

S. No.	Intent	Commands	Voice Feedback
5	BRIGHTNESS DECREASE	Brightness decreased Brightness down Brightness low Reduce the speedo brightness Turn down the brightness Switch the display to night mode Decrease the brightness a bit Decrease the speedo brightness Decrease speedo brightness Go dark	Brightness decreased
6	CURRENT LOCATION	My location Where we right now What is the name of this place Where am i right now & how far we are Where am i now What is my current location Show my location Show my current location Show current location Show location Where are we right now	You are around '____'

S. No.	Intent	Commands	Voice Feedback
7	CALL MISSED	How many missed calls I have	You have ' ____ ' missed call
		Have I missed calls	
		Missed call	
		Number of missed calls	
		Did i get any calls	
		Show me missed calls	
		Update status on the missed call	
8	CALL LAST	Last call	You have last call from ' ____ '
		Who called me last	
		Who called recently	
		Last caller	
		Show my last caller	
		Who is my last caller	

S. No.	Intent	Commands	Voice Feedback
9	SPEED	What is my top speed	Your top speed is '_____' kmph
		My highest speed	
		What is my last high speed	
		Top speed	
		How fast did i go	
		How fast are we	
		Show me the stats for the last ride	
		Tell me the top speed for the last ride	
		Whats my top speed achieved in my last ride	
		What's the top speed we hit toady	
		Show my highest speed	
		Show top speed	
		Show my top speed	
10	SETTING AUTO SMS ENABLE	Enable auto sms	Auto SMS reply enabled
		Auto reply SMS ON	
		Auto SMS ON	
		Auto reply ON	
		Enable auto reply	

S. No.	Intent	Commands	Voice Feedback
11	SETTING AUTO SMS DISABLE	Disable auto sms	Auto SMS reply disabled
		Auto reply SMS OFF	
		Auto SMS OFF	
		Auto reply OFF	
		Disable auto reply	
12	SETTING DND ENABLE	Enable do not disturb	Do not disturb setting enabled
		Do Not Disturb enable	
		Do Not Disturb ON	
		Enable DND	
		DND setting enabled	
		DND mode enabled	
		Do not disturb setting enabled	
Do not disturb mode enabled			
13	SETTING DND DISABLE	Disable do not disturb	Do not disturb setting disabled
		Do Not Disturb disable	
		Do Not Disturb OFF	
		Cut calls while riding	
		Disable DND	
		DND setting disable	
		DND mode disable	
		Do not disturb setting disable	
Do not disturb mode disable			

S. No.	Intent	Commands	Voice Feedback
14	VOLUME INCREASE	Increase volume	Volume Increased
		Volume up	
		Increase sound	
15	VOLUME DECREASE	Decrease volume	Volume Decreased
		Volume down	
		Decrease sound	
		Reduce volume	
16	SETTING HIGH SPEED ALERT ENABLE	Enable high speed alert	High speed alert setting enabled
17	SETTING HIGH SPEED ALERT DISABLE	Disable high speed alert	High speed alert setting disabled



## Note

*The list of commands and intent will be updated periodically. Please refer to the command list mentioned in the mobile app to stay updated.*

Things to do while using voice assistant:

1. We recommend to use ANC (Active Noise Canceling) Bluetooth devices for better performance
2. Ensure Microphone is kept near to your mouth while giving out commands
3. Please ensure that it is not exposed to outside environmental noise such as wind noise, other vehicles' noise etc.
4. We recommend you to go through the sample command list before trying your intent.
5. Kindly refer to the voice feedback of the detected place name when you provide voice command for navigation.

Things not to do while using voice assistant:

1. We recommend you not to use the method of invoking voice assist through mobile App while riding.
2. Please do not use voice assist functionality during heavy traffic condition.

## LED HEAD LAMP

TVS Jupiter ZX comes with a LED head lamp which glows automatically once the engine is started. The head lamp beam (high / low) can be controlled by pressing the 'high / low beam' switch.





## HANDLE BAR LEFT SIDE

### 1. Horn switch

Press the switch '  ' to operate the horn.

### 2. Turn signal lamp switch

Slide the turn signal lamp switch to left '  ' or right side '  ' to operate respective turn signal lamps (LH / RH). Press the switch to turn 'OFF'.



### Warning

*Always use the appropriate turn signal lamps when you intend to change lanes or take turns. Be sure to switch 'OFF' it after negotiating the lanes or turns.*

### 3. Left hand brake lever (SBT brake lever)

Synchronised Braking Technology (SBT) can be operated by pressing the left hand brake lever gently towards the handle grip.

SBT technology helps to operate both front and rear brakes by distributing the force optimally between the two braking system.

### 4. Parking brake (rear brake lock lever)

Brake lock protects your scooter from rolling-off, when parked on side stand# (or) helps you relax while waiting in a long traffic signal (or) a slope.

To activate brake lock, press the brake lever almost half towards the grip and hold, then press the parking brake lever to maximum and release the brake lever slowly. Ensure the brake is locked properly. Pressing the brake lever further releases the brake lock automatically.



#### **Warning**

*Since your vehicle is fitted with SBT brake system it is essential to maintain the brake system in good condition. Adjust the brakes system at regular intervals for the proper working of SBT.*

*Ensure release the brake lock before riding the vehicle.*

### 5. High/low beam cum pass-by switch

**The head lamp glows automatically once the engine is started. Only the head lamp beam (high / low) can be controlled by pressing the 'high / low beam' switch.**

Press the switch towards '  ' to operate head lamp high beam or press it towards '  ' to operate head lamp low beam.

TVS Jupiter ZX has a combined switch for head lamp 'high / low beam' and 'pass-by' operation. To operate the 'pass-by', keep the switch in 'low beam' position, press gently and release. This makes the head lamp high beam to flash and signal the approaching vehicle. The pass-by signal can be used while overtaking during day time.

#### **Warning**

*Use appropriate head lamp beam 'high / low' as per the traffic and road conditions for your safety and to avoid inconvenience to other riders. It is strongly recommended to ride the vehicle in 'low beam' during day.*

*# Side stand and side stand sensor are provided as accessory and will be charged extra*

## HANDLE BAR RIGHT SIDE

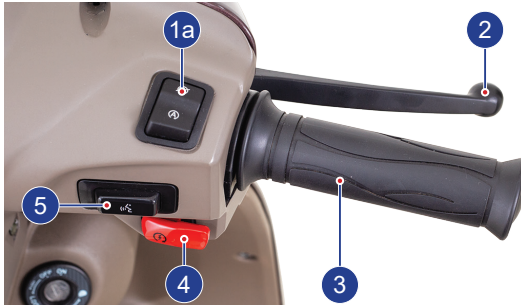

### 1a. 'TVS IntelliGO' switch (incase of disc brake version)

To activate the 'TVS IntelliGO' system, set the IntelliGo switch to 'A' position. The IntelliGo indicator 'A' of the speedometer glows for 2 seconds.

To deactivate 'TVS IntelliGO' system, set the IntelliGo switch to 'A' position.

#### Note

Refer page No. 27 for IntelliGo feature details.

### 1b. Engine kill switch (incase of drum brake version)

It is used to switch off 'X' the engine but to keep other DC system active. The ignition circuit is disabled, preventing the engine from being restarted. To reset the engine, return the switch to the 'O' position.



#### Note

Before starting, ensure to turn 'ON' the engine kill switch and retract the side stand.

## 2. Right hand brake lever

Front brake system can be operated by pressing the right hand brake lever gently towards the throttle grip. The brake lamp glows on application of either right hand or left hand brake lever.

## 3. Throttle grip

Engine speed is controlled by the rotation of the throttle grip. Twist it towards you to increase the engine speed and twist it away from you or release it to decrease the engine speed.



### Caution

*It is not recommended to add any additional throttle grip (cover).*

## 4. Electric starter switch

Retract the side stand<sup>#</sup> and press the starter switch '⊕' to start the engine electrically along with the application of either front or rear brake.

## 5. Voice assist switch

The switch can be used to activate the voice assist



### Note

*Before starting, ensure to retract the side stand<sup>#</sup>.*

*<sup>#</sup> Side stand and side stand sensor are provided as accessory and will be charged extra*

## FUEL TANK## CAP

Fuel tank is located at the rear end of the vehicle below the pillion holder.

To open the fuel tank cap, follow the procedure given in the page No. 25. To close the cap, gently press the cap in its position and ensure locking by hearing 'Click' sound.



## Warning

*Never refill fuel near open flame. Do not smoke while refueling. Do not use cell phones while refueling.*

*## The fuel tank is not a measuring instrument and the capacity of the fuel tank may slightly vary from the indicated capacity.*

## KICKSTARTER LEVER

The kickstarter lever is located on the left side of the vehicle. To start the vehicle, keep the ignition in 'ON' condition and apply the rear brake as a safety precaution to prevent the rear wheel rotation.

Keep your foot on the lever extension as shown in the figure. Kick the lever from top and stroke to bottom with rapid motion.



## EFFORTLESS E-Z CENTRE STAND

TVS Jupiter ZX is equipped with a effortless centre stand. The centre stand (1) has a pivoted flexible spring loaded lever arm (stand extension) (2) to increase the lever ratio, which enables parking on centre stand effortlessly and very conveniently.

To place the vehicle on centre stand, hold the handle bar left grip with left hand. Place your foot firmly on the centre stand extension (2) and press.

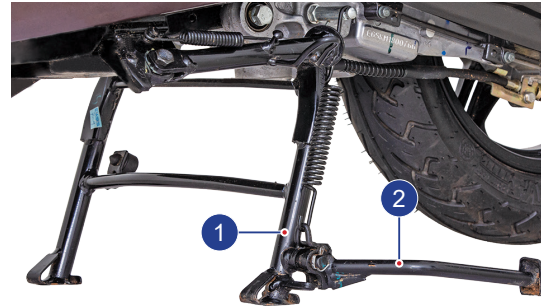

### **SIDE STAND AND SIDE STAND SENSOR#**

Side stand can be operated by sitting on vehicle with your left foot by pushing it away from the vehicle till it stops.



### **Note**

*Please remember that the side stand is provided as accessory and it should be fitted along with side stand sensor# as per regulation.*

### **Warning**

***Always retract the side stand to its full up position before starting the vehicle. Else, the vehicle will not get start.***

### **Caution**

*Never sit on vehicle when it is supported by stands. Always park the vehicle on a flat, firm surface.*

*# Side stand and side stand sensor are provided as accessory and will be charged extra*





## TOOL KIT AND FIRST AID KIT

To assist you in performing certain aspects of periodic maintenance and emergency repairs, a tool kit is supplied along with the vehicle and it is located below the seat base. To access the tool kit, seat need to be opened. Follow the procedure given in the page No. 25 for the seat opening procedure.



### **Caution**

*It is recommended to use the tool kit in case of any emergency only. It is always advisable to take your vehicle to TVS Motor Company Authorised Main Dealer / Authorised Dealer.*

The tool kit consists one number each of the following. Ensure the contents of the tool kit.

1. 10x12 mm spanner
2. Combination screw driver bit
3. Screw driver handle
4. Tool bag

## UTILITY BOX

Utility box is located below the seat. Lift the seat by unlocking the seat lock as explained in the page No. 25 to access the utility box.



## Caution

*Utility box can be used to carry a load of 10 kg maximum.*

*Do not carry perishable items inside the utility box. It is not fully sealed. Do not allow / spray water to get inside the utility box. Take care not to spill petrol or oil into the utility box.*

*Do not keep heat-sensitive items inside as it may get hot on long rides. **Do not keep valuable items inside the utility box when leaving the vehicle unattended.***

## Warning

*Operating the TVS Jupiter ZX overloaded will hamper the riding stability and may lead to loss of control. Hence, it is advisable to carry the recommended amount of load only.*



### GLOVE BOX FRONT

TVS Jupiter ZX is provided with glove box front. Which has 1 liter storage capacity and used to hold your mobiles while charging or hold a small bottle.



### **Warning**

*Ensure that your mobile or any material stored is safely held with in the glove box front while riding your TVS Jupiter ZX.*

### HELMET HOOKS

Two helmet hooks are provided under the seat assembly at front end near the seat hinge to secure your helmet. Open the seat assembly as explained in the page No. 25 to access the helmet hooks.

Hook the helmet strap in the helmet hook properly and close the seat assembly.

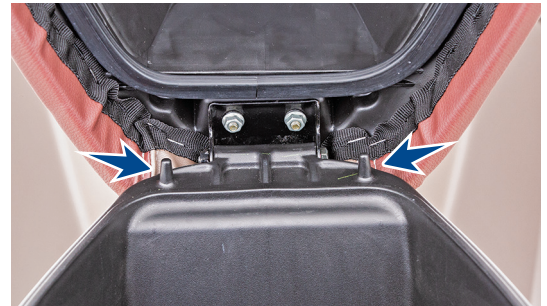

## BAG HOOKS

There are two bag hooks provided with your scooter to carry light luggage like carry bags weighing upto 3 kg. One hook is located below handle bar on the rear panel.

Just pull out the hook from the top (A) to hang your luggage. Push back the hook once it is free.

Similarly, the other one is located on the cover front below front end of the seat assembly. Pull out the hook from its position. Open the top lid and hang your cargos. Lid will get close automatically. Push back the hook to its original position once it is free.



### Caution

*Care should be taken not to attach the luggage which hangs out of your scooter. Please note that the luggage attached to your scooter should not interfere your feet movement.*

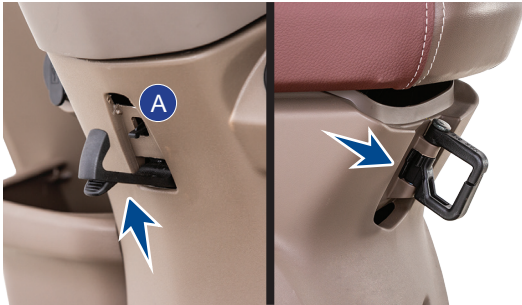

### SMART PHONE CHARGER#

This smart phone charging socket enables you to charge your smart phone when you are traveling. This socket is located below left side of handle bar. Please go through the operating manual of the mobile phone and use a suitable adaptor for the battery operation recommended by the mobile phone manufacturer for that particular model. Please follow the guidelines provided for the proper usage of the socket:

#### DO's

1. Ensure that no water enters into the socket by closing the USB flap properly.
2. Use only mobile phone company's authorized USB cable for mobile charging.
3. Do make sure the flap is not damaged while opening / inserting the USB cable.

#### DON'Ts

1. Do not leave the USB charging flap open / partially closed.
2. Do not attempt to use / charge any other device, other than one mobile phone at a given time.
3. Do not try to force the USB connector in, check if it is inserted in the appropriate direction, to prevent damage.

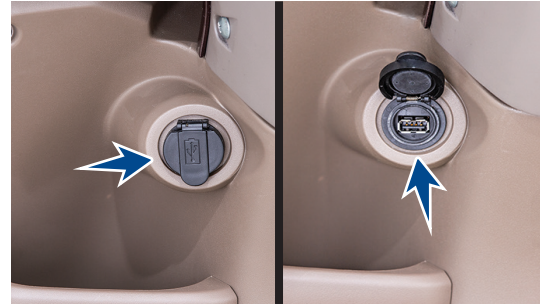

4. Do not charge your mobile when the engine is in OFF condition.
5. Do not use other device, this port is for charging mobile phones only.

#### **Caution**

*Secure your mobile phone properly during charging and protect it from any liquid, dust etc.*

# Mandatory and optional accessory will be charged extra

## PRE RIDE INSPECTION

Check the following items before riding

ITEM	WHAT TO CHECK FOR
Engine oil	Availability of oil upto the level (page No. 87)
Transmission oil	Availability of oil upto the level (page No. 88)
Fuel	Enough fuel for the planned distance of running
Tyres	Correct pressure (page No. 95) Adequate tread depth / No cracks or cuts.
Battery	Proper working of electric starter, horn, fuel gauge, pass-by, brake lamp, tail lamp, speedoback illumination, license plate lamp and turn signal lamps.
Lighting	Proper working of head lamp high / low beam and high beam indicator
Steering	Smooth movement / No play or looseness
Throttle	Correct free play of cable / Smooth operation
Brakes	Correct brake play (page No. 89) Availability of brake fluid upto the level (page No. 89)
Wheels	Free rotation
Malfunction indicator	Turned OFF after the engine is started (page No. 29)
ISG malfunction indicator	Turned OFF after the Ignition 'ON' and engine is started (page No. 26)

### **Caution**

*Do not switch 'ON' the ignition without minimum level fuel in tank. It will cause damage to the fuel pump.*

## STARTING THE ENGINE

Ensure availability of fuel in the fuel tank. Insert the control key into the ignition cum steering lock and turn it to the 'ON' position. In side stand\* retracted condition, apply any one of the brake and press the electric starter switch to start electrically or kick start. Press the start button (one touch noiseless start) without applying the throttle. As soon as the engine starts, release the start button. The engine will not start if the throttle is opened full.

### Setting the vehicle in motion

1. Twist the throttle grip slowly towards you and simultaneously release the brake lever gently and smoothly. The vehicle will start moving forward.
2. As the vehicle picks up speed, increase the throttle slowly.

### Stopping and parking

1. Close the throttle completely and apply both the brakes simultaneously.
2. Turn the ignition 'OFF'.
3. Park the vehicle on a firm, flat surface.
4. Lock the steering and take out the control key. Finally close the safety key shutter lock.

### Warning

*Do not raise the throttle rapidly so the vehicle will move forward suddenly and lead to loss of control.*

*Reduce speed to a safe limit before turning / cornering. Do not apply brake while turning / cornering.*

### Caution

*Do not keep the engine in idling rpm for long and do not open excessive throttle when the vehicle is parked. It leads to overheating of engine and damage to the internal components.*

\* Side stand and side stand sensor are provided as accessory and will be charged extra

## FUEL RECOMMENDATION

Use only BS VI petrol with minimum RON 91. BS VI petrol containing upto 20% of ethanol by volume can be used.

Higher ethanol content in petrol can lead to

- degrade plastic and rubber components of fuel system and vehicle parts
- cause corrosion damage to metal parts like fuel tank, etc
- result in startability & drivability issues
- decrease fuel economy

Ethanol absorbs water very easily, resulting fuel separation. Extra care shall be taken to prevent moisture entry into fuel tank while filling ethanol blended petrol and water washing of vehicle.

Painted parts (viz. panels, covers) shall not come in contact with ethanol blended fuels.

Manufacturer is not responsible for any warranty issues that results from using ethanol blend in excess of 20% by volume in petrol.

In case of any abnormalities observed due to use of ethanol blended fuels, customers are advised to use a different fuel station / brand for standard E20 fuel or contact authorised service centres.



## Caution

*Never mix oil in petrol in the fuel tank. Always fill fuel from the reputed and reliable fuel stations.*

## CHECKS AND TIPS FOR IMPROVING FUEL ECONOMY

### Regular checks

Carry out the periodic maintenance checks as specified in this manual (page No. 77).

Regular maintenance checks will save fuel and ensure trouble-free, enjoyable and safe riding besides keeping environment clean.

### Spark plug

A dirty or defective spark plug leads to wastage of fuel due to incomplete combustion. Clean and adjust the spark plug only if necessary. Replace the spark plug every 12000 kms (1 year). Always use recommended spark plug only.

### Air cleaner element

A dirty air cleaner element restricts airflow and increases fuel consumption. Replace the element every 12000 kms.

Since paper filter is used in your scooter it is not recommended to clean the filter. Replace the filter incase of any abnormalities.



### Engine oil and Transmission oil

Dirty or less engine oil increases friction between various parts of the engine and reduces the engine life, thereby increases the fuel consumption.

Running with low transmission oil will cause damage to the gears and bearings. **Regularly inspect the engine oil and the transmission oil for correct level and top-up if necessary. Get it replaced at regular intervals as per the maintenance schedule.**

### Fuel leak

Inspect and arrest fuel leaks if any from tank and fuel lines. Loss of fuel due to leak may drain the fuel tank completely.

### Evaporation

Vehicle parked in the hot sun leads to wastage of fuel through evaporation. Also, lower fuel levels in the tank will have increased evaporation and condensation of moisture inside. Ensure to close fuel tank cap after every filling. If the fuel tank cap kept open for long time, it leads to safety and fuel loss.

### Tyres

Low tyre pressure has adverse effect on the vehicle. The **drag on the vehicle** increases resulting in decreased fuel economy. Further more, handling may be adversely affected.

Inspect the tyre pressure regularly (weekly) and inflate it to the recommended pressure (refer page No. 95). Never use tyres which are worn beyond the permissible limit.

### Wheel freeness

Inspect and ensure the wheel freeness by rotating the wheel at least once in a week to avoid wastage of fuel.

### Avoid unnecessary idling

While waiting for someone or stopping in signals for long time, if the engine is kept running at idle speed, it causes unnecessary wastage of fuel.

### Avoid frequent braking

Anticipate corners and slopes as well as the traffic conditions. **Unnecessary and frequent braking will reduce the fuel economy. Never accelerate and apply brake simultaneously.** It leads clutch shoes wear and wastage of fuel.

### Note

*The on-road mileage of TVS Jupiter ZX is dependent on several factors like road condition, quality of fuel, riding speed, operation of clutch and brake, tyre inflation, maintenance / timely servicing of vehicle, load etc. and hence will differ from the mileage given under standard test conditions such as made in recognised institutes.*

## MAINTENANCE SCHEDULE

The maintenance schedule indicates the intervals between periodic services. At the end of each interval, be sure to inspect, check, replace, adjust, lubricate and service as instructed. If the maintenance is not done periodically, it will result in rapid wear and severe damage to the vehicle. If the vehicle is used under high stress conditions such as continuous full throttle operation or if used / operated in dusty climate, certain jobs should be performed more often to ensure reliability of the vehicle. Cylinder head, steering components, suspension and wheel components etc., are key items and require very special and careful servicing. TVS Motor Company Limited strongly recommends that the jobs as per the maintenance schedule be performed by your TVS Motor Company Authorised Main Dealer / Authorised Dealer.

Periodic inspections may reveal one or more parts that may need replacement. Whenever replacing parts on TVS Jupiter ZX, it is recommended that you use only the TVS Motor Company Genuine parts.

### **Caution**

*Proper running-in and maintenance are mandatory for making certain that your vehicle is reliable and gives optimum performance at all times. Make sure that the periodic maintenance is performed thoroughly in accordance with the instructions given in this owner's manual.*

*In more dusty areas, the air filter element required early replacement than the mentioned kilometers to avoid costly damages to the engine.*



## PERIODIC MAINTENANCE SCHEDULE (months or km whichever occurs earlier)

Item	Service km	In free service				After free service		Remarks
		1st 500 - 750 2 months	2nd 2500 - 3000 4 months	3rd 5000 - 6000 8 months	4th 8500 - 9000 12 months	Every 3000 km 4 months	Every 6000 km 8 months	
Engine oil		R	I & T	R	I & T	I & T	R	
Oil filter (strainer)		C	-	C	-	-	C	
Transmission oil		R	I & T	R	I & T	I & T	R	
Spark plug		I	-	-	-	-	-	Inspect, Clean and adjust if required, Replace every 12000 km
Air cleaner element		I	-	-	-	-	-	Replace every 12000 km
Air cleaner oil collection tubes		-	I & DR	I & DR	I & DR	I & DR	-	Drain oil if necessary
CVT filter element <sup>1</sup>		-	-	I & C	-	-	I & C	Replace every 12000 km
Tappet clearance		I	-	I & A	-	-	I & A	Inspect for any noise / starting trouble and adjust if required
Drive belt and CVT rollers		-	-	-	-	-	-	Replace every 24000 km
Cover variator <sup>2</sup>		-	-	I, C & L	-	-	I, C & L	
Clutch shoe		-	-	-	-	-	-	Replace every 24000 km
Hose fuel		-	-	-	-	-	-	Replace every 3 years
Front and rear suspension		I	I	I	I	I	-	Inspect for proper functioning

R - Replace; I - Inspect; T - Top up; C - Clean; A - Adjust; DR - Drain; L - Lubricate; TI - Tighten; S - Set

<sup>1</sup> Inspect for damage

<sup>2</sup> Clean the cover with air. Lubricate kick starter with Bechem grease

contd...

Item	Service km Period from the date of sale	In free service				After free service		Remarks
		1st 500 - 750 2 months	2nd 2500 - 3000 4 months	3rd 5000 - 6000 8 months	4th 8500 - 9000 12 months	Every 3000 km 4 months	Every 6000 km 8 months	
All control cables <sup>3</sup>		I, A & L	I, A & L	I, A & L	I, A & L	I, A & L	-	
Throttle grip		-	-	L	-	-	L	Lubricate using grease
Steering smooth operation / play		I & A	-	-	-	-	-	C, L & A with fresh grease every 12000 km
Speedo hub drive / cable		-	-	L	-	-	L	Lubricate using grease
Front fork oil		-	-	-	-	-	-	Replace every 24000 km
All fasteners		I & TI	I & TI	I & TI	I & TI	I & TI	-	
All bulbs, horn and switches		I	I	I	I	I	-	Inspect for proper functioning
Head lamp beam		I & A	I & A	I & A	I & A	I & A	-	
Battery voltage <sup>4</sup>		I	I	I	I	I	-	
Brake effectiveness / play		I & A	I & A	I & A	I & A	I & A	-	Refer page No. 58 & 61 for details
Brake shoe / pad wear		I	I	I	I	I	-	Replace if necessary
Brake fluid		I & T	I & T	I & T	I & T	I & T	-	Replace every 21000 km or 2 years whichever occurs earlier
Brake hose		I	I	I	I	I	-	Replace every three years
Master cylinder cups		-	-	-	-	-	-	Replace every 21000 km

R - Replace; I - Inspect; T - Top up; C - Clean; A - Adjust; DR - Drain; L - Lubricate; TI - Tighten; S - Set

<sup>3</sup> Inspect for proper operation and adjust play. Lubricate ends using grease

<sup>4</sup> Recharge if necessary

contd...

Item	Service km	In free service				After free service		Remarks
		1st 500 - 750 2 months	2nd 2500 - 3000 4 months	3rd 5000 - 6000 8 months	4th 8500 - 9000 12 months	Every 3000 km 4 months	Every 6000 km 8 months	
Wheel freeness		I	I	I	I	I	-	
Front wheel bearing		-	-	-	-	-	-	Lubricate using grease every 12000 km
Tyre pressure at cold condition		I & S	I & S	I & S	I & S	I & S	-	
Malfunction indicator lamp		I	I	I	I	I	-	<i>Check and resolve the errors using diagnostic tool if the lamp is ON even after starting the engine</i>
Evaporative emission control system		I	I	I	I	I	-	Check for intactness of hoses and canister
Fuel tank assembly**		I & C	I & C	I & C	I & C	I & C	-	
Centre / side stand pivot		L	L	L	L	L	-	Lubricate using TRU4 oil
Kick starter pedal pivot		L	L	L	L	L	-	Lubricate using TRU4 oil

R - Replace; I - Inspect; T - Top up; C - Clean; A - Adjust; DR - Drain; L - Lubricate; TI - Tighten; S - Set

\*\* Check for abnormal vehicle jerk / noise while opening the cap / leak. If found any, contact TVS Motor Company Authorised Main Dealer or Authorised Dealer.

## RECOMMENDED LUBRICANTS

APPLICATION	QTY	MANUFACTURER	BRAND
Engine oil	750 ~ 800 ml (during regular service) 800 ml (incase of disassembly)	TVS Motor Company	TVS TRU4 SKUUTA oil (SAE 10W30 API-SL, JASO MB)
Transmission oil	100 ml (during regular service) 120 ml (incase of disassembly)	-do-	-do-
Front fork oil	84 ± 1 ml / leg	IOC	Gabriel Premium front fork oil
Disc brake fluid	-	TVS Girling	DOT 3 / DOT 4
Grease	-	Bharat petroleum IOC Bechem Kluber Lubrication	MP Grease No. 3 Servo Gem No. 3 Bechem premium grade 3 Kluber Centoplex 2

## SELF - MAINTENANCE PROCEDURES

### MAINTENANCE FREE (MF) Battery

Battery is located at the front of vehicle inside the front panel. This panel must be removed to access the battery.

1. Follow the procedure for front panel removal:
2. Remove the front panel mounting screws shown in the figure (4 Nos.).
3. Remove the license plate front mounting screws (A) (2 Nos.) and take out the license plate front.
4. Remove the bracket license plate mounting hexagonal bolts (B) (2 Nos.) and take out the bracket license plate.

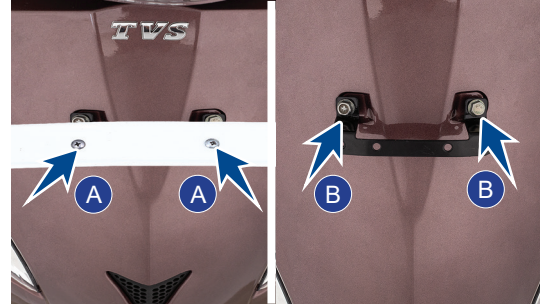

5. Gently pull out the front panel by dislocating its lugs.
6. During reassembly reverse the removal procedure.

Since the maintenance free battery is fitted in your vehicle it is not necessary to top-up with the distilled water. But to ensure the battery performance and long life, follow the steps given below:

1. Check the battery voltage as per the schedule. If the voltage is less than 12.4 volts, charge the battery using **recommended MF battery charger** at TVS Motor Company Authorised Main Dealer / Authorised Dealer.

 **Caution**

*Never check the battery charge by shorting the terminals. Always connect the positive terminal first (red wire) and then negative (black wire) to avoid sparking.*

*The inversion of the battery wires can damage the battery and the recharging system. Always connect the positive then negative to avoid sparking.*

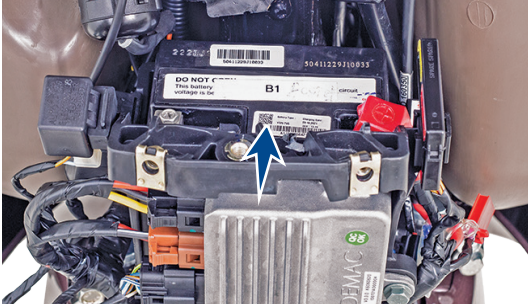

2. Do not add any additional electrical accessories.
3. While connecting the terminals, observe the correct polarity. Connect the red wire to the '+' terminal and black wire to the '-' terminal of the battery.
4. Petroleum jelly must be applied at terminals to prevent it from corrosion.
5. In case of any abnormality or for removal of battery from the vehicle, contact TVS Motor Company Authorised Main Dealer / Authorised Dealer.



## Recommendations to maintain battery health during prolonged parking conditions

While your vehicle is parked for prolonged duration, battery continues to discharge and if left unattended can get completely discharged. It is recommended to ride the vehicle for minimum 60 km every week to keep the battery in healthy condition. This could be at a stretch in one ride or several rides during the week.

The vehicle speed will vary during the ride but an average speed of minimum 30 kmph will be helpful to ensure proper battery charging. Use kick-starting, if available, to conserve battery charge during such period. This is only a recommendation to maintain battery charge and regular service schedules must be followed to maintain your vehicle in good running condition.

The following is recommendations to users regarding battery maintenance before, during and after long storage of battery:

### 1. Before Storage

- Store the battery only after fully charging it
- Battery fuse to be disconnected and stored safely. This will reduce the sleep mode current and hence enhance storage life of battery.##

- Alternatively, battery connecting wires (positive and negative wires) can be disconnected and fasteners can be secured with battery terminals.##

### 2. During Storage

- Store it at room temperature or lower.
- Store the vehicle in the shade and protected from rain and cover the vehicle to prevent rodents from entering and damaging the wires.

### 3. After Storage

- Connect the wires and fuse, if disconnected earlier, with ignition switch in OFF position#
- Start the vehicle by kick starting.

(Above recommendations do not consider storage effects on other systems such as induction and fuel systems and wheels)

### Periodic Maintenance of Batteries:

- Keep top of battery clean
- Check cables, clamps, and case for obvious damage or loose connections

## To be done by skilled personnel

- Clean terminals and connectors as necessary
- Recharge battery if voltage is below 12.4V.
- Valve Regulate Lead Acid (VRLA) / Lead Acid batteries are prone to water damage. Any water entry, through vents or otherwise; will result in irreparable damage to the battery or the vehicle.

 **Warning**

*Battery develop explosive gases. Keep it away from heat sources. If charging is required the battery must be charged in well ventilated area.*

*Unusable battery must be disposed in environment friendly manner. Do not discard it with household thrash. Handover the battery to the battery dealers or to a recycle center that accept used battery.*

 **Caution**

*Never operate the vehicle with discharged battery as it may damage electrical components.*

*Do not push start the vehicle, use a good battery to start the vehicle.*

## FUSE

Non-working of electrical systems may be due to safety fuse failure. Short circuit or overload in the electrical system are the main causes for fuse failure. There are two fuse cases containing three blade type fuses (15A x 1 and 10A x 2) located near the battery. Follow the procedure given below for inspecting and replacing the fuse.

1. Turn 'OFF' the ignition.
2. Remove the front panel as explained earlier.
3. Take out the fuse cases located near from the battery one by one.
4. Open the fuse cases and take out the fuses.

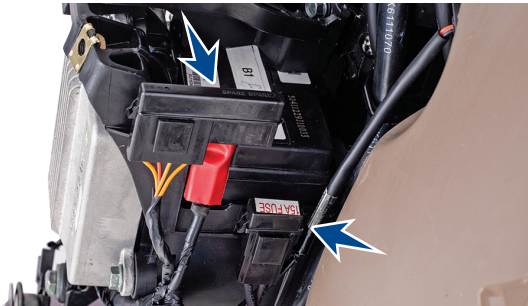

5. Inspect the fuse for failure. If found defective, replace the fuse with a new (extra fuse provided in the wiring harness itself in a pouch or provided inside the fuse case itself).
6. Close the fuse case and re-fix it into the battery box.
7. Turn 'ON' the ignition switch and check for proper functioning of electrical systems. In case the fuse fails again, consult the nearest TVS Motor Company Authorised Main Dealer / Authorised Dealer.

Good Fuse

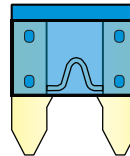

Blown Fuse

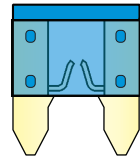

### Caution

Do not use the vehicle by **shorting the wires without fuse**. This may result in overheating of electrical items / wiring and may result in fire. Do not use fuse of higher amperage than specified for the safety of electrical system.

## SPARK PLUG

To access the spark plug, the cover front has to be removed. Follow the procedure to remove the cover front.

1. Open the seat and remove the top mounting screws (A) from both the sides of cover front.
2. Remove the bottom mounting bolt (B) of cover front.
3. Gently pull out the cover front by dislocating its lugs.
4. Clean the dust and mud around the spark plug mounting to avoid falling inside the cylinder.

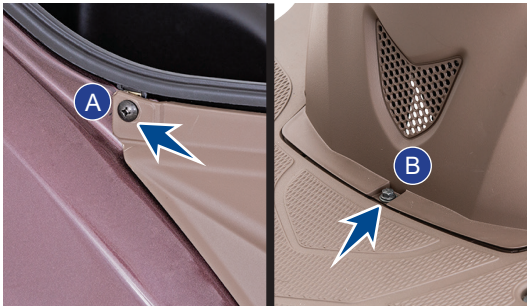

5. Pull out the suppressor cap from spark plug. Using the spark plug spanner, remove the spark plug.

A spark plug with heavy carbon deposits will not produce strong sparks. Hence, only if necessary, clean the carbon deposits from the spark plug with a small wire brush or spark plug cleaning tool.

Inspect the spark plug electrodes (A) and (B) for any corrosion. If found any, replace the spark plug with a new. Inspect the spark plug gap with a wire gauge / feeler gauge. Readjust the spark plug gap to **1.0 ~ 1.1 mm** if required.

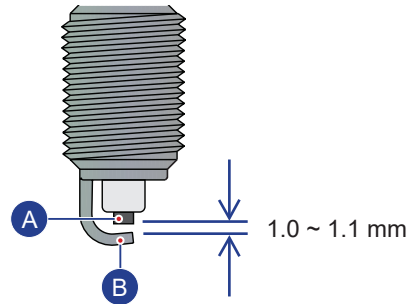

After cleaning and adjusting the gap, reinstall the spark plug and tighten by hand to avoid cross threading. Finally tighten using spark plug spanner.

### **Caution**

*Always use only recommended make and type of spark plug. **Replace spark plug every 12000 km.***

*Don't remove the spark plug when the engine is hot. Cover the spark plug hole with cloth when the plug is removed, to prevent dust / water entry.*

*It is advisable to tighten the new spark plug by hand till the end, using plug spanner tighten by 1/4 turn. Then loosen the plug by 1/8 turn and re-tighten using plug spanner.*

## ENGINE OIL LEVEL

Check the engine oil level periodically.

1. Place the vehicle on centre stand on a flat surface. Wipe-off the surroundings of gauge oil level.
2. Remove the gauge and wipe it clean.
3. Fix the gauge back to its mounting hole. Do not thread in.
4. Take out the gauge and check the oil level. The level should be between minimum and maximum level marks of the gauge (shown in the figure).
5. If the oil is less than the minimum level, add 'TVS TRU4 SKUUTA oil (SAE 10W30 API-SL, JASO MB)' upto the maximum level mark.

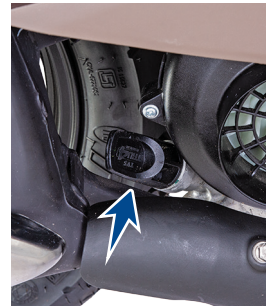

6. Wipe out the oil traces with a clean cloth to prevent dust accumulation.
7. Assemble back the gauge oil level.

### TRANSMISSION OIL - LEVEL

Check the transmission oil level periodically. To check the transmission oil level follow the procedure given below:

1. Place the vehicle on centre stand on a flat surface.
2. Wipe-off the surroundings of oil level screw.
3. Remove the transmission oil level screw along with a gasket from the rear end of crankcase L.

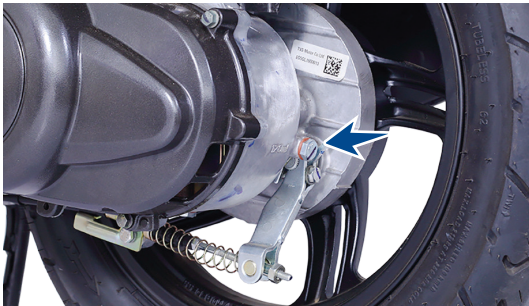

4. Check for the flow of oil from oil level hole. If the level is less (if there is no oil flow), top-up with 'TVS TRU4 SKUUTA oil (SAE 10W30 API-SL, JASO MB)' till the oil just starts to flow out from the oil level hole.
5. Wipe out the oil traces with a clean cloth to prevent dust accumulation.
6. Replace the fiber washer while reassembling the oil level screw.

### **Caution**

*If the vehicle is driven with less engine and transmission oil, the engine components will be severely damaged.*

*Check the oil level as per the schedule to avoid costly damage. Do not fill excess oil may cause oil leak. Always use 'TVS TRU4 SKUUTA oil (SAE 10W30 API-SL, JASO MB)' only.*

## BRAKES

### Front brake - SBT Disc type

1. You can observe a master cylinder (1) right side of the handle bar under the head lamp housing.
2. A caliper assembly (2) fitted to the fork leg L, a disc (3) on the front wheel and a high pressure hose (4) connecting the master cylinder and the caliper assembly.
3. Check the master cylinder brake fluid level through the view piece glass (A).
4. The brake fluid level always should be above the 'MIN' mark (B) provided on the view piece glass of the master cylinder when the cylinder is parallel to ground.

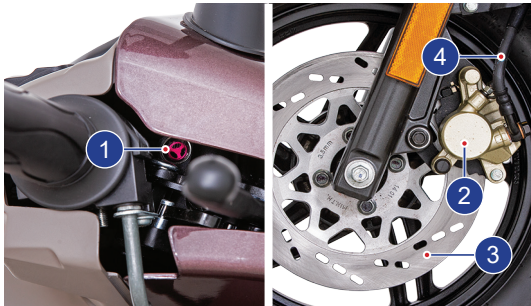

5. If the brake fluid level is below the 'MIN' mark or while applying brake if you feel the brake is more spongy or ineffective due to air entry and if any rattling play is observed in both the brake levers, contact TVS Motor Company Authorised Main Dealer or Authorised Dealer for topping-up the brake fluid, air bleeding and other brake related inspections.

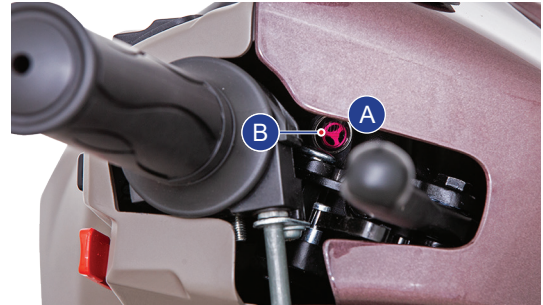

### Warning

*In case of vehicle fitted disc brake SBS version, if there is any abnormality in brake performance, contact TVS Motor Company Authorised Main Dealer / Authorised Dealer.*

### Brake pad wear indicator (Front brake)

Check for the wear of brake pads visually. If the brake pads wear is found beyond the wear indicator groove as shown in the figure, replace the brake pads as a set with a new one.

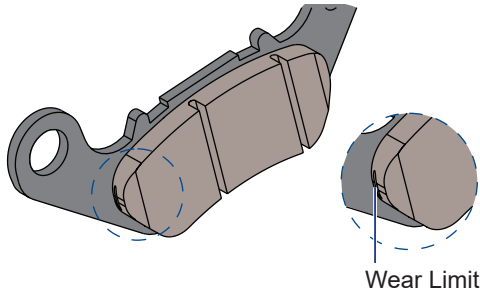

### Front brake - SBT Drum type

1. Measure the free play of the front brake lever at the lever end as shown in the figure.
2. The free play of the brake lever before the engagement of brake should be between 15 ~ 20 mm.
3. Turn the adjuster nut at the bottom side (1) in the slot marked as '1' in clockwise direction for reducing the free play or in anti-clockwise direction for increasing the free play.

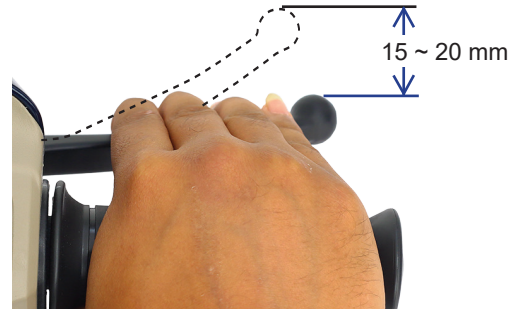



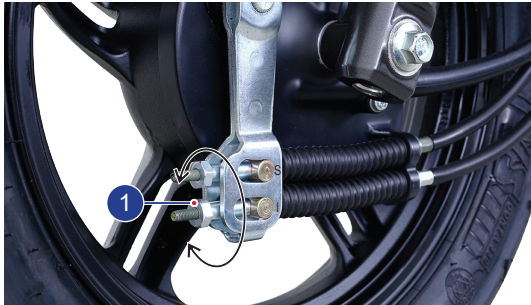

4. After obtaining the necessary free play, inspect for the clearance between the bullet (3) and slot end (4) marked as "S" as shown in the figure.

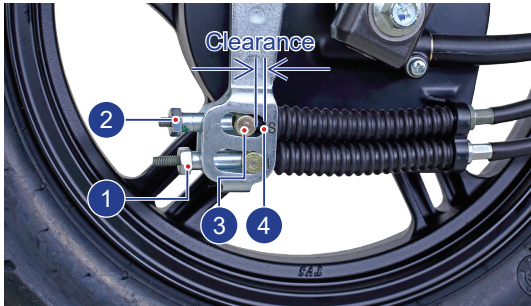

5. If any clearance is found, turn the adjuster nut (2) at the top side in the slot marked as 'S' in clockwise direction until there is no clearance between the bullet top (3) and the slot top (4).

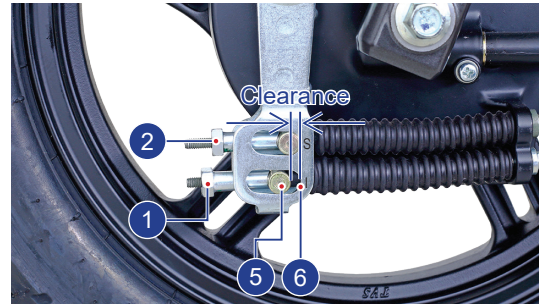

6. After adjusting the adjuster nut top, If any clearance is observed in between the bullet bottom (5) and the slot bottom (6) marked as 'I' as shown, then turn the adjuster nut (2) in anti-clockwise until there is no clearance.
7. Once again check and confirm the brake play at the lever end.

## Warning

Since the vehicle is fitted with Synchronised Braking Technology (SBT) adjust the brakes with additional care. If not it may result in brakes not working properly. Please contact TVS Motor Company Authorised Main Dealer or Authorised Dealer for further assistance.

### Brake shoe wear indicator - Front

When the brake is applied, wear limit index mark (1) on the front brake cam should be within the wear limit indicator (2) on the front brake panel.



Incase the wear limit index mark (1) is going beyond wear limit indicator (2), index the lever to next slot with the help of the Dealer to extend the shoe life.

### Rear brake

1. Measure the free play of the rear brake lever at the lever end as shown in the figure.
2. Free play of brake lever before the engagement of brake should be between 10 ~ 15 mm.



### Note

Please remember that the rear brake lever free play adjustment to be done only after adjusting the front brake lever play.

3. If the measured distance is more than the limit, adjust the nut provided at the rear wheel end to obtain the correct play.
4. Turn the adjuster nut in clockwise direction for reducing free play or in anti-clockwise direction for increasing the free play.



### **Warning**

Check brake play periodically. However the brake play needs to be adjusted more frequently depending upon the usage.

### **Brake shoe wear indicator (Rear brake)**

When brake is applied, the wear limit indication pointer (1) on the rear brake cam lever should be within the wear limit indicator (2) on the crankcase LH.

In case the wear limit indication pointer (1) is going beyond wear limit indicator (2), index the lever to next slot with the help of Dealers to extend shoe life.

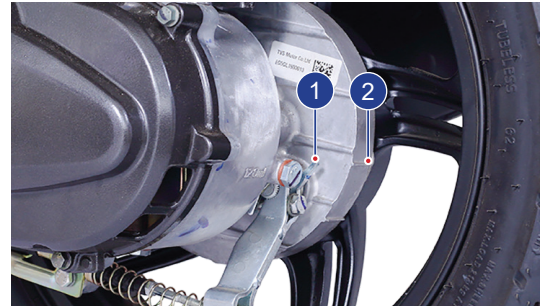

### **Caution**

Replace the brake shoes as a set, if the wear limit indicator of front and rear brake shows beyond the wear limit even after indexing the lever.

## REAR SHOCK ABSORBERS

TVS Jupiter ZX is provided with 3 step adjustable rear shock absorbers to meet different road and load. There are 3 notches for adjusting spring load.

If the spring is adjusted to the minimum notch, then the shock absorber will be softer which is good for light loads. If the spring is adjusted to maximum notch, then it will be stiffer which is good for heavy loads.

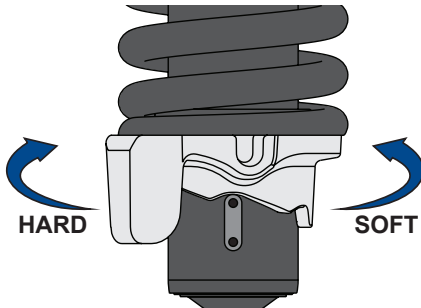

Adjust the spring pre-load by shifting the adjuster to the required notch according to the different load conditions. The more you compress the spring, the suspension becomes more stiff.

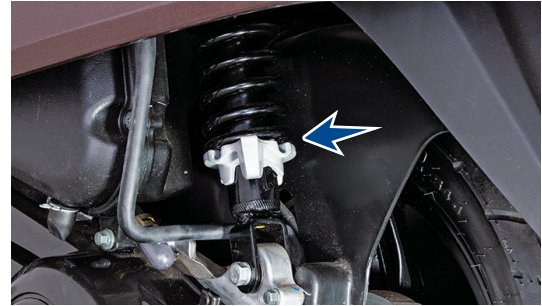

## TYRES

### Tyre pressure

Check the tyre pressure atleast once in a week if not more frequently. Insufficient air pressure in the tyres not only hasten the tyre wear, but also seriously affects the stability of the vehicle.

Under inflated tyres make smooth cornering difficult and over inflated tyres decreases the tyre contact with the ground which can lead to skidding and loss of control.

Be sure that the tyre pressure is within the specified limit at all times.

Tyre pressure in cold condition:

	<b>Solo</b>	<b>Dual</b>
Front	1.70 kg/cm <sup>2</sup> (24 PSI)	1.70 kg/cm <sup>2</sup> (24 PSI)
Rear	2.25 kg/cm <sup>2</sup> (32 PSI)	2.53 kg/cm <sup>2</sup> (36 PSI)

### Tyre tread condition

Operating the vehicle with excessively worn tyres will decrease riding stability and can lead to loss of control. It is recommended to replace the tyre when the tyre wears off to the tyre wear indicator level (indicated by TWI (A) on the tyre).



### Tyre rotation direction

While reassembling the tyres, after removing from the wheel rim, ensure that the arrow mark facing the direction of wheel rotation while fixing the tyre on the wheel rim.

### Tyre puncture

Your scooter is fitted with a tubeless tyre on both front and rear wheel. Incase of any puncture / tyre damage, it is advised to visit the nearest tyre manufacturer Dealer or the tyre repair shops who knows the repairing method of tubeless tyre.

It is not necessary to remove the tyre from wheel rim always to attend a puncture.

Even though, if there is need of tyre removal, it is strongly recommended to use a tyre removal / fitment machine.

If at all, tyre levers needs to be used, the levers should be free from sharp edges. Care should be taken not to damage the tyres and rims.

### **Warning**

*The tyre inflation pressure in cold condition and the tyre tread condition are extremely important for the performance and safety of the rider. Check the tyres frequently for inflation pressure as well as the wear pattern on it.*

*Use of a tyre other than the standard may cause instability.*

### **Caution**

*The side walls of the tubeless tyre which in contact with the wheel rim are only seals the air inside the wheel assembly. Hence care should be taken not to damage the side walls of the tyres during removal / reassembly.*

## Tyre Maintenance Tips

### Inflation Pressure Check - Condition



### Note

*If vehicle is in hold condition for long time*

- *Need movement of vehicle to avoid particular spot of tyre not to touch the ground for more than week time.*
- *Inflation pressure should check on cold condition maximum travel time should not exceed more than 1 km.*
- *Weekly basis inflation pressure check helps to improve 10% of tread life & fuel efficiency.*

## FRONT WHEEL REMOVAL AND REASSEMBLY

1. Remove the axle nut (1) along with a washer.
2. Pull out the axle (2) along with a washer and take out a spacer from the right side of the wheel.
3. Place a support below the foot board to prevent the vehicle from falling and lift the vehicle up.
4. Dislocate the wheel disc from caliper assembly and take out the wheel along with hub drive.
5. Reverse the procedure for reassembling. Ensure the proper seating of wheel disc in the caliper assembly and lug on fork leg R to the slot in the hub drive while reassembling.



## REAR WHEEL REMOVAL AND REASSEMBLY

1. Place the vehicle on the centre stand.
2. Hold the rear brake firmly and remove the wheel mounting nut (A) along with a washer.
3. Slightly tilt the vehicle and take out the wheel from the rear axle.
4. Reassemble the wheel in the reverse order of removal.

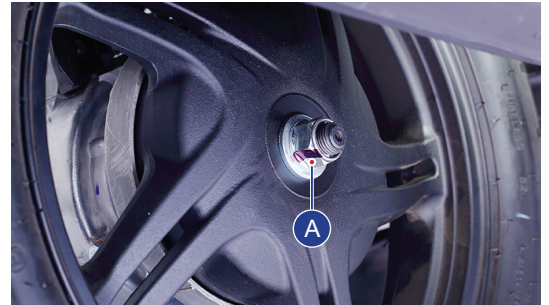

### **Warning**

*Always make sure, whenever the wheel is removed, the axle nuts are tightened properly to the specified torque.*



## STORAGE PROCEDURES

For storage of your scooter for longer period of over a month and above, we recommend to carry out the following steps:

1. Clean the vehicle thoroughly. Park the vehicle on centre stand.
2. Warm up the engine and drain engine oil and transmission oil. Store the oil, if new, in a dust free container.
3. Empty the fuel tank.
4. Remove the spark plug and feed in several drops of engine oil through spark plug hole. Crank the engine few times and reinstall the spark plug.
5. Remove the battery, store it away from direct sunlight and freezing temperatures.
6. Place a suitable support at the bottom of the foot board so that both the tyres are off the ground. This will ensure better tyre life.
7. Cover up the vehicle completely with a clean tarpaulin or any other suitable cover. Store the vehicle inside a garage or similar area to avoid damage due to dust and rain. Make sure that the storage area is well ventilated and free from any source of flame or spark.



### Caution

*Do not park the vehicle on a slope or soft ground or else it may fall down. The exhaust system becomes hot after a run. Park the vehicle in a place where pedestrians or children are not likely to touch the vehicle.*

*During storage, the battery must be recharged at recommended charger if stored more than a month.*

## TAKING THE VEHICLE OUT OF STORAGE FOR REGULAR USE

1. Take the vehicle out of garage and clean it thoroughly.
2. Remount the battery after bench charging if required.
3. Fill the engine oil (TVS TRU4 SKUUTA - SAE 10W30 API-SL, JASO MB oil) and check the oil level using gauge oil level.
4. Fill the transmission oil (TVSTRU4 SKUUTA - SAE 10W30 API-SL, JASO MB oil) and check the oil level at the oil level screw.
5. Lubricate the parts as instructed in the periodic maintenance schedule.
6. Fill up fresh petrol in the fuel tank.
7. Check and inflate the tyres to the specified tyre pressure.
8. Check and correct the points mentioned in page No. 72.
9. Turn the ignition switch to 'ON' position. Retract the side stand<sup>#</sup> if the vehicle is parked on side stand<sup>#</sup>. Start the engine and ride out.



### Caution

*Avoid using alkaline solution like detergent soaps for washing. This may damage head lamp and other lamp assemblies.*

*<sup>#</sup> Side stand and side stand sensor are provided as accessory and will be charged extra*



## RECOMMENDED TIPS WHEN TAKING A LONG TRIP OF MORE THAN 500 KM:

- A) Please keep the following items for use in case of emergency:
1. Tool kit complete.
  2. Recommended spark plug one number.
  3. Turn signal lamp bulb one number.
  4. Throttle and rear brake cable each one.
  5. First aid kit.
- B) Precautions to be taken for the journey:
1. Ensure engine oil and transmission oil are up to the level.
  2. Adequate fuel in the fuel tank.
- C) Check your scooter for the following:
1. Tightness of all bolts and nuts with correct torque value.
  2. Fitness of tyres / tyre pressure / tread depth.
  3. All bulbs, indicators and horn functioning.
  4. Smooth functioning of all cables and their free play.
  5. Smoothness of steering operation.
  6. Front / rear brake function and rear brake lamp working.

7. Front fork for any abnormality.
8. Spark plug gap and condition of spark plug.
9. Air filter element cleanliness.
10. Correct idling speed.
11. Lubrication of all items mentioned in the periodic maintenance schedule.
12. Any other job as necessary.
13. Have your vehicle checked at any TVS Motor Company Authorised Main Dealer or Authorised Dealer.



### Caution

*Long journey are to be taken only after the running-in period of 1000 km.*

**TVS Motor Company Limited ('the Company') give this warranty with respect to the TVS Jupiter ZX manufactured by the Company.**

While the Company has taken every care to maintain quality in the manufacture of the TVS Jupiter ZX, the above said warranty is subject to other terms of warranty:

During 5 Years from the date of purchase or during the first 50,000 km of run for the vehicle in the hands of original retail purchaser, whichever is earlier, the parts of the vehicle covered under warranty which prove to the satisfaction of the Company to have a manufacturing defect will be repaired or replaced free of cost.

The Company's obligation under this warranty is limited to repairing or replacing, free of cost, those parts of the vehicle which upon examination by the Company may prove to the Company's satisfaction to have a manufacturing defect, and in such cases the Company's decision either to repair or replace the affected parts will be final. In the event of replacement of parts, the Company also reserves the right to use parts of the same brand as the affected parts or any other brand which is used by the Company in the course of manufacture. All parts replaced under this warranty will become the property of the Company and must be returned to the company.

**Limitations of Warranty:**

This warranty shall not apply to following condition:

1. Any natural wear and tear, including without limitation, aging.
2. Warranty claims on proprietary items such as tyres, tubes and batteries etc., should be preferred by the user directly on the respective manufacturer, as per their warranty terms and the Company shall not be liable in any manner in respect to the same.
  - Battery warranty for "MF type (Maintenance Free)" is applicable for a period of 21 months from the date of charging or 18 months from the date of sale or 20,000 kms, whichever is earlier.
  - Battery warranty for "Lead Acid type" is applicable for a period of 15 months from date of charging or 12 months from date of sale or 10000 kms whichever is earlier.
3. Parts repaired or replaced under this warranty are warranted only throughout the remainder of the original warranty period.



4. The Company is not liable for any delay in servicing due to reasons beyond the control of the Company or any of its Authorised Main Dealers / Authorised Dealers.
5. In any event, the Company is not liable for indirect, remote, incidental or consequential damages.
6. The Company may make any modification or improvement to vehicles in future production at any time without prior notice and without any obligation to install the same on vehicles previously dispatched for sale.
7. Any claim under this warranty will lie only when the customer:
  - takes his vehicle to an Authorised Main Dealer / Authorised Dealer of the Company and reports the problem he / she felt in the vehicle to enable the Authorised Main Dealer / Authorised Dealer to inspect the same and assess the cause for the reported problems.
  - produces to such Authorised Main Dealer / Authorised Dealer the owner's manual for the concerned vehicle for verification of relevant details.
8. This is the only warranty given by the Company for the TVS Jupiter ZX. No employee, Dealer or other person is authorised to extend or enlarge this warranty.

 **Warning**

*Modifications to this vehicle not approved by the TVS Motor Company may cause loss of performance and render it unsafe for use and disqualifies for warranty coverage also.*

**Following Toll Free numbers can be contacted for battery related queries if any.**

Incase of EXIDE battery, call :- 1800 103 5454

Incase of AMCO battery, call :- 1800 425 0096

Incase of TATA GREEN battery, call :- 1800 419 8888

Incase of AMARON battery, call :- 1800 425 5858

**Following Toll Free numbers can be contacted for Tyre related queries if any.**

Incase of TVS Srichakra, call :- 04522443300

Incase of JK tyre, call :- 18002581100

Incase of Maxxis tyre, call :- 1800 532 2888

## List of parts not covered under warranty

ITEM	WHAT TO CHECK FOR
Normal Maintenance Operations	Engine tune-up, decarbonizing, fuel system cleaning, oil changes, head light focusing, fastener retightening, ignition timing, clutch and brakes as well as other normal adjustments.
Wear and Tear Items	Chain, sprockets, clutch and brake linings / pads, brake disc, fasteners, shims, washers, oil seals, gaskets, O' rings and spokes etc.
Electrical	Bulbs, fuse etc.
Service Maintenance Parts	Oil filters, spark plug, air filter, SAI filter, oil and brake fluid
Rubber, Rexine and Plastic Items	All hoses, pipes and plastic aesthetics
Proprietary Items	<p>Battery, tyres and tubes (the warranty terms are subject to our agreement with proprietary OEM)</p> <p>(Battery warranty for "MF type (Maintenance Free)" is applicable for a period of 21 months from the date of charging or 18 months from the date of sale or 20,000 kms, whichever is earlier).</p> <p>(Battery warranty for "Lead Acid type" is applicable for a period of 15 months from date of charging or 12 months from date of sale or 10000 kms whichever is earlier).</p>
Others Factors	Parts of the vehicle getting affected due to atmospheric effect / environmental factors (rusting, paint peel off etc.). However, depending on the vehicle usage condition, warranty would be accepted up to 2 years from the date of purchase.
	Parts of the vehicle which have been tampered with, altered, repaired or replaced by persons not authorised by the Company and which in the sole judgement of the Company affect the performance of the vehicle.

## List of parts not covered under warranty

ITEM	WHAT TO CHECK FOR
Others Factors	Parts which are used in conjunction with parts not made or recommended by the Company.
	Parts suffering damage or resultant damage by accident, misuse, negligent treatment, use of bad quality lubricants or impure fuel or by omission to follow the guidance and instructions contained in this owner's manual.
	Vehicles on which engine number or chassis number is deleted, defaced or altered.
	Vehicles on which any warranty service including scheduled paid service is not availed when it falls due (at TVS Motor Company Authorised Main Dealer / Authorised Dealer).
	<p>Vehicles sold or transferred by original retail purchaser.</p> <p>Vehicles used for racing or any competition or used otherwise than for ordinary personal transportation.</p> <p>Vehicles attached with side cars etc.</p> <p>Vehicles which have been taken out of India.</p> <p>Vehicles affected by natural calamities like flood, earthquake, tsunami, storm etc,.</p>
	If the vehicle has been used for commercial purpose like taxi or used for rental or hiring or any other purpose other than regular personal transportation.

## SERVICE INFORMATION

There are seventeen services for TVS Jupiter ZX during warranty period. Of these, first four services are free services for which labour charges are free. In addition to these four free services, we have a scheme of thirteen pay services. For keeping the maintenance track of your vehicle, free and pay service record sheets are attached in the Service Handbook given to you during the time of your vehicle purchase. Please have the relevant record sheet filled by the Dealer who is carrying out the maintenance service.

For availing any of the seventeen warranty services, please take your vehicle and your Service Handbook to any of our Authorised Main Dealers or any of our Authorised Dealer. After effecting the service the Authorised Main Dealer or the Authorised Dealer will affix their stamp on the last column of free or pay service record sheet of Service Handbook for your record and reference. An OTP would be sent to customer's registered mobile number. The same to be shared with the servicing Dealer on or before vehicle delivery.

Periodic maintenance always helps good performance of an automobile and our services are planned to keep your TVS Jupiter ZX performing good. **Please note that carrying out the service for your vehicle at scheduled intervals at any of the TVS Motor Company Authorised Main Dealer / Authorised Dealer is necessary for availing of warranty.** And please also remember that, after the services are over, periodic servicing of your vehicle at appropriate intervals, depending upon its extent of use, will keep your vehicle at its best level of performance.

In case you need any clarification or assistance, please feel free to write to us mentioning the frame number, engine number and date of purchase of your vehicle also the name and place of the Authorised Main Dealer / Authorised Dealer from whom you bought the vehicle and getting it serviced.

### Service Department

**TVS MOTOR COMPANY LIMITED**

**P.O. Box No. 4, Harita, Hosur - 635 109,**

**TAMILNADU, INDIA.**

**Toll free no:- 1800-258-7111**



### Planned Service Schedule (kms or month whichever of the two occurs early)

Sl.No.	Service	Type	Kms	Months
1	1st Service	Free	500 ~ 750	2
2	2nd Service		2500 ~ 3000	4
3	3rd Service		5000 ~ 6000	8
4	4th Service		8500 ~ 9000	12
5	5th Service	Pay	11500 ~ 12000	16
6	6th Service		14500 ~ 15000	20
7	7th Service		17500 ~ 18000	24
8	8th Service		20500 ~ 21000	28
9	9th Service		23500 ~ 24000	32
10	10th Service		26500 ~ 27000	36
11	11th Service		29500 ~ 30000	40

Sl.No.	Service	Type	Kms	Months
12	12th Service	Pay	32500 ~ 33000	44
13	13th Service		35500 ~ 36000	48
14	14th Service		38500 ~ 39000	51
15	15th Service		41500 ~ 42000	54
16	16th Service		44500 ~ 45000	57
17	17th Service		47500 ~ 48000	60

### Note

*Free service enables the customer to avail the service at free of labour charges. Charges for the pay service should be borne by the customer. Cost of engine oil, periodic maintenance parts, filter, brake fluids, all types of greases, petroleum jelly, distilled water, chain cleaner, lubricants, coolants, cleaning cloths for both free and paid services are chargeable to the customer.*

***Please remember that, after the above schedule, periodic servicing of your vehicle at appropriate intervals, depending upon its extent of use, will keep your vehicle at its best level of performance.***

DESCRIPTION	TVS Jupiter ZX
<b>MANUFACTURER</b>	TVS Motor Company Limited P. B. No. 4, Harita, Hosur - 635 109, India  TVS Motor Company Limited Village Bhatian, Bharatgarh Road, Teh Nalagarh, Dist. Solan. Himachal Pradesh - 174 101, India
<b>ENGINE</b>	
Type	Single cylinder, 4 stroke, fuel injection, air cooled, spark ignition engine
Cylinder bore	53.5 mm
Stroke	48.8 mm
Piston displacement	109.7 cc
Compression ratio	10 ± 0.5 : 1
Air filter	Dry paper filter element with dry foam
Oil filter	Wire mesh
Lubrication system	Forced wet sump
Maximum power in kW	5.8 kW @ 7500 rpm
Maximum torque in Nm	8.8 Nm @ 5500 rpm
Maximum speed	78 km/h
Engine idling rpm	1450 ± 200 rpm (under warm condition)
Starting system	Kick starter / Electric starter
Emission norms	BS VI

DESCRIPTION	TVS Jupiter ZX
<b>TRANSMISSION</b>	
Clutch	Dry - Centrifugal clutch
Primary transmission	CVT (Continuously Variable Transmission)
Primary reduction	2.58 to 0.8
Secondary reduction	10.47
<b>CHASSIS</b>	
Overall length	1834 mm
Overall width	650 mm
Overall height	1115 mm
Seat length	782 mm
Ground clearance (unladen)	163 mm
Wheel base	1275 mm
Kerb weight (with toolkit and 90% of fuel)	Disc : 107 kg and Drum : 104 kg
Pay load	130 kg
Maximum laden weight	Disc : 237 kg and Drum : 234 kg
Steering angle	90°
Caster angle	25°
Frame	High rigidity underbone type
Front suspension	Telescopic hydraulic
Rear suspension	Toggle link, gas filled hydraulic damper
Trail length	93 mm

DESCRIPTION	TVS Jupiter ZX
<b>BRAKES</b>	
Front (Disc)	220 mm dia (hand operated)
Front (Drum)	130 mm dia (hand operated)
Rear (Drum)	130 mm dia (hand operated)
<b>TYRE</b>	
Front tyre	90/90 - 12 54J (tubeless)
Rear tyre	90/90 - 12 54J (tubeless)
Front tyre pressure**	1.70 kg/cm <sup>2</sup> (24 PSI)
Rear tyre pressure - Solo**	2.25 kg/cm <sup>2</sup> (32 PSI)
Rear tyre pressure - Dual**	2.53 kg/cm <sup>2</sup> (36 PSI)
<b>ELECTRICAL</b>	
Ignition system	ECU controlled ignition
Spark plug	BOSCH UR5KCU / CHAMPION RG8MC5
Spark plug gap	1.0 ~ 1.1 mm
Battery type	12V, 3Ah / 4Ah MF battery
Generator (flywheel magneto)	12V, 130W
Head lamp	9V, 9.5W High beam LED / 6V, 5W Low beam LED
Tail / brake lamp	12V, 10/5W

\*\* In cold condition

DESCRIPTION	TVS Jupiter ZX
<b>ELECTRICAL</b>	
Turn signal lamps bulb	12V, 10W x 4
Number plate lamp bulb	12V, 4W x 1
Instrument cluster	LCD / LED indicators
Horn	12V, DC
Fuse (blade type)	12V, 15A x 1 and 12V, 10A x 2



### Caution

*Using the bulb other than the specified rating can result in overloading of the electrical system or premature failure of the bulb.*

DESCRIPTION	TVS Jupiter ZX
<b>CAPACITIES</b>	
Fuel tank capacity**	5.8 l
Fuel	BS VI petrol with minimum RON 91 (containing upto 20% of ethanol by volume)
Engine / transmission oil grade	TVSTRU4 SKUUTA oil (SAE 10W30 API-SL, JASO MB)
Engine oil capacity	750 ~ 800 ml (during regular service) 800 ml (incase of disassembly)
Transmission oil capacity	100 ml (during regular service) 120 ml (incase of disassembly)
Front fork oil grade	Gabriel Premium front fork oil
Front fork oil capacity	84 ± 1 ml per leg
Disc brake fluid	TVS Girling DOT 3 / DOT 4

 **Note**

*Specifications are subject to change without notice.*

\*\* The fuel tank is not a measuring instrument and the capacity of the fuel tank may vary from the indicated capacity

Dear Customer,

It is mandatory under the Motor Vehicles Act to insure all motor vehicles. No motor vehicle can be used in a public place without a valid policy of insurance issued by an authorised insurer. Driving a motor vehicle without any such insurance is an offense under Motor Vehicles Act.

To assist our Customers on their insurance requirements such as the prompt issue and renewal of policies as well as expeditious settlement of claims if any, our preferred insurers are:







ALWAYS USE TVS-M GENUINE PARTS

 tvsjupiter | [www.tvsjupiter.com](http://www.tvsjupiter.com) | **Call: 1800 315 7777.**



**TVS MOTOR COMPANY LIMITED**

P. B. No. 4, Harita, Hosur - 635 109, Tamil Nadu, India.  
Telephone: +91 (04344) 276780 Fax: +91 (04344) 276878  
[www.tvsmotor.com](http://www.tvsmotor.com)