

# OWNER'S MANUAL



**TVS**  
**Jupiter 125**  
**ZYADA SE BHI ZYADA**



SCAN FOR 24X7  
ROADSIDE ASSISTANCE NOW

**WE GO THE DISTANCE  
WHEN IT COMES  
TO YOUR ASSISTANCE.**

MAKE YOUR RIDES HASSLE-FREE AND STRESS-FREE  
WITH SERVICE BEYOND JUST ASSISTANCE.

Sign up for our 24X7 Roadside Assistance and enjoy  
quick and efficient service anytime, anywhere.





**Drive In.**

**Drive Out.**



**Say bye-bye to waiting time  
for servicing your bike.**

**Get your vehicle serviced in 1 hour at no additional cost. Contact your nearest Dealership for details.†**

† Facility available at selected Dealerships only. Terms and conditions apply





# Busy Life? Easy Servicing!

Now, service your bike anywhere, anytime.

- ★ Service the vehicle at your door step.
- ★ Available for regular maintenance or breakdown service only.
- ★ Offered at nominal convenience charges.

Contact your nearest Dealership for details.<sup>†</sup>

<sup>†</sup> Facility available at selected Dealerships only. Terms and conditions apply





# Busy Life? Easy Servicing!

Now, service your bike anywhere, anytime.

- ★ Service the vehicle at your door step.
- ★ Available for regular maintenance or breakdown service only.
- ★ Offered at nominal convenience charges.

**Contact your nearest Dealership for details.<sup>†</sup>**

<sup>†</sup> Facility available at selected Dealerships only. Terms and conditions apply

EXPRESS SERVICE	I
EXPERT ON WHEELS	II
PICKUP AND DROP	III
CONTENTS	IV
CONTACT(S) FOR SUPPORT	1
FOREWORD	5
UNIQUE FEATURES OF TVS JUPITER 125	6
ACCESSORIES	10
SAFETY INFORMATION	11
NOTICE	12
RUNNING-IN INFORMATION	13
SAFE RIDING TIPS	14
KNOW YOUR TVS JUPITER 125	18
RIDING YOUR TVS JUPITER 125	44
MAINTENANCE	48
WARRANTY AND SERVICES	73
TECHNICAL SPECIFICATIONS	79
GENERAL INFORMATION	84

**Incase you need any Clarification please contact  
TVS Motor Company Authorised Main Dealer / Authorised Dealer**

**Or**

**TVS Motor Company's Area Offices (flip over for addresses)**

**Or**

**Toll Free Number : 1800-258-7111**

**Email : [customercare@tvsmotor.com](mailto:customercare@tvsmotor.com)**

**Disclaimer :** TVS Motor Company or any of its officials / Authorized Main dealer / Authorized Dealer do not ask customers for bank / card / wallet details / authentication. In case you face any such claim, please report to the relevant local authorities immediately.

## CONTACT AT OUR AREA OFFICES

### TAMILNADU-1, 3 & 4

#### 1. TVS Motor Company Limited

V Floor, Gee Gee Universal,  
No. 2, MC Nichols Road,  
Chetpet, Chennai - 600 031.  
Phone : 044-28361651/28361654  
Email : AO.Chennai@tvs motor.com  
AO.Madurai@tvs motor.com

### TAMILNADU-2

#### 2. TVS Motor Company Limited

No. 10, 2nd floor,  
Shree Shanmugapriya Towers,  
Kannuswamy Street,  
Behind Hotel Annapoorna,  
R S Puram, Coimbatore - 641 002.  
Phone : 0422-4350060/2541035  
Email : AO.Coimbatore@tvs motor.com

### KERALA

#### 3. TVS Motor Company Limited

Ambady Towers, Second Floor,  
Door No. 27/631, A6,  
Edappally-Pookkattupady Road,  
Edappally PO., Cochin - 682 024.  
Phone : 0484-2544578/2556938  
Email : AO.Cochin@tvs motor.com

### KARNATAKA-1, 2 & GOA

#### 4. TVS Motor Company Limited

No. 600, Anand Surya, 2nd Floor,  
15th Cross, 6th Phase, JP Nagar,  
Opp. BMTC Bus Stop,  
Bangalore - 560 078.  
Phone : 080-26653433  
Email : AO.Bangalore@tvs motor.com

### ANDHRAPRADESH & TELANGANA

#### 5. TVS Motor Company Limited

Rukumani Towers, First Floor,  
No. 3-11-30, Plot No. 11,  
Paigha Colony, Behind Anand Theater,  
Secunderabad - 500 003.  
Phone : 040-27840590/27844419  
Email : AO.Hyderabad@tvs motor.com  
AO.Vijayawada@tvs motor.com

### MAHARASHTRA-1 & 2

#### 6. TVS Motor Company Limited

No. 401, 4th Floor, The Chambers,  
Plot No. 4/12/3, Near Ganapati Chowk,  
Viman Nagar, Pune - 411 014.  
Phone : 020-26632112/26632110  
Email : Service.pune@tvs motor.com

### MAHARASHTRA-3 & CHATTISGARH

#### 7. TVS Motor Company Limited

No. 502B, 6th Floor, B Wing,  
Shriram Shyam Towers,  
Near LIC Square, Sardar,  
Nagpur - 440 001.  
Phone : 0712-2569932  
Email : Service.Nagpur@tvs motor.com  
AO.Rajpur@tvs motor.com

### GUJARAT

#### 8. TVS Motor Company Limited

1208-1213, Shivalik Satyamev,  
Below Bopal Over Bridge,  
Ambli-SP Ring Road Junction, Bopal,  
Ahmedabad- 380 058.  
Phone : 079-65443748  
Email : AO.Ahmedabad@tvs motor.com



**MADHYA PRADESH-1 & 2****9. TVS Motor Company Limited**

No. 211-212, 2nd Floor,  
Chinar Incube Business Centre,  
Chinar Fortune City,  
Near Brindhavan Dhaba,  
Hosangabad Road,  
Bhopal - 462 026.  
Phone : 0755-2499406/2499306  
Email : AO.Bhopal@tvsmotor.com  
AO.Indore@tvsmotor.com

**RAJASTHAN-1 & 2****10. TVS Motor Company Limited**

Plot No. 17-18,  
2nd Floor of National Motors Building,  
Jhotwara Industrial Area,  
Jaipur - 302 012.  
Phone : 0141-5150901/5150902  
Email : AO.Jaipur@tvsmotor.com  
AO.Udaipur@tvsmotor.com

**DELHI & HARYANA****11. TVS Motor Company Limited**

D-3 & D-4, 2nd Floor,  
Sector - 10, Noida,  
Uttar Pradesh - 201 301.  
Phone : 011-29834640/29834773  
Email : AO.Delhi@tvsmotor.com

**PUNJAB & CHANDIGARH****12. TVS Motor Company Limited**

4th Floor, Royal Business Park,  
Chandigarh Ambala Highway,  
Zirkapur - 140 603.  
Phone : 01762-464777/465777  
Email : AO.Chandigarh@tvsmotor.com

**UTTAR PRADESH WEST****13. TVS Motor Company Limited**

D-3 & D-4, 2nd Floor,  
Sector - 10, Noida,  
Uttar Pradesh - 201 301.  
Phone : 011-29834640/29834773  
Email : AO.Delhi@tvsmotor.com

**UTTAR PRADESH CENTRAL & EAST****14. TVS Motor Company Limited**

1st Floor, Cyber Tower, TC-34/V-2,  
Vibhuti Khand, Gomti Nagar,  
Lucknow - 226 010.  
Phone : 0522-4918300/4918301  
Email : AO.Lucknow@tvsmotor.com

**WEST BENGAL****15. TVS Motor Company Limited**

Ground Floor & First Floor,  
133 A. S. P. Mukherjee Road,  
Opp. Tollygunge Police Station,  
Kolkatta - 700 026.  
Phone : 033-24617096/24617092  
Email : AO.Kolkatta@tvsmotor.com

**BIHAR****16. TVS Motor Company Limited**

N-Plaza, Jamal Road,  
P.S. Kotwali,  
Patna - 800 001.  
Phone : 0612-2200068/2200069  
Email : AO.BNJ@tvsmotor.com

## **ORISSA & JHARKHAND**

### **17. TVS Motor Company Limited**

No. 303, 3rd Floor,  
Creative Plaza, Rasulgarh,  
Bhubaneswar - 751 010.  
Phone : 0674-2580019  
Email : AO.Bhubaneswar@tvs motor.com

## **NORTH EAST STATES**

### **18. TVS Motor Company Limited**

147, Udayan, Ganesh Guri,  
Near Hotel D Courtyard,  
R G B. Road, Guwahati - 781 005.  
Phone : 0361-2202030/2202031  
Email : AO.Guwahati@tvs motor.com

Dear Jupiter 125 Owner,

Thank you for choosing TVS Jupiter 125. Taking the legacy of TVS Jupiter forward, the all new TVS Jupiter 125 is truly bigger, better and powerful. With its Next Gen 125cc engine and many class-leading features it is the perfect new age scooter. As a proud owner of TVS Jupiter 125, you are now part of the TVS family with millions of satisfied customers.

The TVS Jupiter 125 comes with new unique features which have been developed keeping your needs in mind - Best in class underseat storage with twin helmet space, best in class mileage, longest seat in the segment, front fuel fill, metal body, signature style elements and much more. Overall, the TVS Jupiter 125 is a perfect blend of style, performance and utility.

All the features of your new vehicle, along with information on how it operates is available in this manual. Kindly read it carefully and follow the instructions to enjoy years of comfortable and safe riding. To ensure reliable performance, we urge you to get your TVS Jupiter 125 serviced only at TVS Motor Company Authorised Main Dealer / Authorised Dealer at specified intervals.

Experience the next level of commuting with the all new TVS Jupiter 125!

**TVS MOTOR COMPANY LIMITED**

## UNIQUE FEATURES OF TVS JUPITER 125

### SEMI DIGITAL SPEEDOMETER

Your scooter has been provided with semi digital speedometer which is equipped with innovative features like Digital fuel indicator, Time indication, Digital odometer, Distance to empty, Average fuel efficiency, Instantaneous fuel efficiency, Trip meter A, B & F, Service reminder, Helmet indication and more.

TRIP F: Trip F is a unique feature in your vehicle which would indicate the number of kilometers driven in reserve condition. This would be a critical information to prevent fuel shortage during ride.

### ECONOMETER®

Your scooter's speedometer has ECONOMETER® which indicates whether you are riding in 'Economy' mode or 'Power' mode. This is an unique feature of your scooter which guides you to ride your scooter fuel efficiently. Refer page no. 27 for details.



### INTEGRATED GENERATOR (ISG)

'Integrated Starter Generator (ISG)' system delivers a noiseless start of your scooter.

### 'TVS intelliGO'

An intelligent start / stop system that further enhances fuel efficiency. Easy on your pocket and kinder to the environment. Refer page no. 26 for details.

### LOW FUEL INDICATOR

'Low Fuel Indicator' is yet another unique feature of your scooter which indicates you to refill the fuel, when the fuel in the tank goes below minimum safe level. Refer page no. 28 for details.

### SIDE STAND CUT-OFF

Your scooter has been provided with auto engine cut-off and start control system when the side stand is engaged.



### ALL IN ONE LOCK

Your scooter has all in one lock that unlocks the seat and fuel tank cap at the ignition lock itself. Refer page no. 23 for details.



### FRONT FUEL FILL

Front fuel filling system enables you to hassle free fuel filling without even getting off from the vehicle.



### PASS-BY SWITCH

Pass-by Switch is a feature that allows you to easily switch between high & low beam of the head lamp with easy press and auto release. It is helpful especially while overtaking. Refer page no. 35 for details.



### SEAT ASSEMBLY

Longest seat in its category with 790 mm length for comfortable travels of your family members.



### 'TVS intelliGO' SWITCH

An exclusive intelliGO switch is provided to switch 'OFF' and 'ON' the intelliGo system as and when required. Refer page no. 36 for details.



### LED HEAD LAMP

Your scooter comes in with a premium LED head lamp. Efficient and bright, this gives your scooter a totally upgraded Look and Style with better visibility for night rides.



### PATENTED E-Z CENTRE STAND

E-Z Center Stand of your scooter reduces the effort required to place the scooter on stand. Refer page no. 38 for operating procedure.



### **PARKING BRAKE (REAR BRAKE LOCK)**

'Parking Brake' is another unique safety feature which protects your scooter from falling due to wheel rotation when it is parked with the side stand on a slope. Refer page no. 35 for details.



### **RETRACTABLE BAG HOOKS**

Your scooter has two retractable 'Bag Hooks' to carry light luggage like carry bags weighing upto 3 kg. One hook is located below the handle bar on the rear panel and the other one is located on the cover front below the front end of seat.



### **TELESCOPIC FRONT FORK**

Your scooter has Motorcycle-like 'Telescopic Front Suspension' for extreme riding comfort even while riding on bad roads.



### **GAS ADJUSTABLE REAR SHOCK ABSORBER**

Your scooter comes with gas filled 'Adjustable Rear Shock Absorber' with canister - First time in scooters. This allows you to adjust the required level of hardness / softness as per the usage requirement at just the push of a lever.



### **SYNCHRONISED BRAKE TECHNOLOGY (SBT)**

Taking technological innovation to next level, your scooter comes with 'Synchronised Brake Technology (SBT)'. This feature enhances the safety by avoiding skidding during sudden braking.



### **UNDER-SEAT STORAGE (UTILITY BOX)**

Your scooter has a 33 litre under-seat storage space to carry your luggage belongings, two helmet etc., refer page no. 40 for details.



### **BLACK LARGER ALLOY WHEELS**

All 'Larger Black Alloy Wheels' with high mechanical advantage gives progressive braking of your scooter, results in best-in-class 'shortest distance' braking. It also provide superior comfort in bad road conditions.



### **TUBELESS TYRES**

Another important unique feature in your scooter is 'Tubeless Tyres'. Tubeless tyres reduce the chances of getting punctured. Even if there is a puncture, sudden leakage of air is avoided, thereby provide better safety and convenience. It is also very easy to repair the punctured tyres.



### **FRONT GLOVE BOX**

Your scooter is provided with glove box front. Which has 2 liter storage capacity and used to hold your mobiles while charging or hold a small bottle.



### ACCESSORIES FOR YOUR SCOOTER

#### SMART PHONE CHARGER\*

Your scooter is provided with a socket for charging your smart phone even while you are traveling and it is located below the right side of the handle bar. Refer page no. 42 for usage details.



#### UTILITY BOX LIGHT\*

Your scooter has a provision to fix 'Utility Box Light' which lights up the utility box automatically whenever the seat is open.



#### INDICATOR BEEPER\*

Your scooter has an electronic beeper which alerts you that the turn signal indicators and side stand is 'ON'. This beeper comes as a mandatory accessory.

#### LADY PILLION HANDLE\*

Provision for mounting 'Lady pillion handle' is provided in your scooter. Lady pillion can be purchased as optional accessory.

#### LADY PILLION FOOT REST\*

Your scooter has a provision to fit 'Lady pillion foot rest' for easy resting of legs for the ladies travelers as a pillion and it is a mandatory accessory.

*\* Mandatory and optional accessory will be charged extra*



Operating this vehicle safely is an important responsibility of the rider. To help you make decisions on safety, we have provided necessary operating procedure and other information in this manual. This information alerts you on potential hazards that could hurt you or others. Since it is not possible to warn you about all the hazards associated with operating or maintaining the vehicle, you must use your own judgment.

You will find important safety information in following form in this manual. These words carry the following connotations:

 **Warning**

*Disregarding this message might result in **injury to the rider or deadly accidents.***

 **Caution**

*This message indicates special procedures or precautions to be followed to **avoid damage to the vehicle.***

 **Note**

*This message provides further clarification for **clear understanding of any particular information.***

Take time to familiarize yourself with your TVS Jupiter 125 and its performance characteristics.

This Owner's Manual contains a host of useful information. Please take the time to read this manual before you ride your new TVS Jupiter 125. Get familiarised with the operation of your scooter for maximum safety and pleasure. The better you know your vehicle, the more pleasure you will experience riding your new vehicle. Ensure that anyone else riding your TVS Jupiter 125 does the same.

All information, illustrations, photographs and specifications contained in this owner's manual are based on the latest product information available at the time of this publication. TVS Motor Company Limited may, however, incorporate modifications or improvements on its vehicles at any time without notice, and therefore, in such events it is possible that the relevant part of the owner's manual does not apply to your vehicle.

Prior permission of TVS Motor Company Limited is required for quoting, copying or reproducing any part of this owner's manual.

### Note

*Accessories shown in the picture may not be part of the standard equipment.*

*Pictures shown in this manual are of TVS Jupiter 125 alloy wheel with front Disc brake model unless specified.*

***Your scooter is provided with always glowing head lamp (AHO). The head lamp glows automatically once the engine is started.***

***TVS Jupiter 125 fitted with 'TVS intelliGO' which is an intelligent start/stop system that switches 'OFF & ON' the scooter automatically (refer page no. 26 for further details).***

***Since your vehicle is fitted with side stand cut-off system ensure to retract the side stand before starting the vehicle.***



The first 1000 km is a crucial part of your scooter. Proper running-in operation during this period helps in ensuring a **maximum life** and **smooth performance** of your scooter.

The reliability and performance of your scooter depends on the special care and restraint exercised during the running-in period. It is especially important that you avoid operating the engine in high speed (RPM), which could expose the engine parts to excessive stress. Recommended speed during the running-in is:

**Maximum 50 km/h speed upto 1000 km** (vary the engine speed for better mating of parts).

**The first free service at 500 ~ 750 km is most important.** During running-in period all the engine components and other parts will have set in. All adjustments to be restored, all fasteners to be tightened. **Engine and Transmission oil to be replaced.** Timely performance of the first free service will ensure optimum service life and performance from the engine.

 **Caution**

*Replacing the engine and transmission oil during first service is most important for better life of engine. Always use TVS TRU4 SKUUTA (SAE 10W30 API-SL, JASO MB) oil for better performance and life.*

## SAFE RIDING RECOMMENDATIONS

Any two wheeler riding requires some precautions to be taken to ensure the safety of the rider, pillion rider and other road users. These precautions are:

### Familiarise yourself with new TVS Jupiter 125

Riding skill and your mechanical knowledge form the foundation of safe riding practices. We suggest you to practice riding TVS Jupiter 125 in a low-traffic condition until you are thoroughly familiar with your vehicle and its controls. Remember practice makes you perfect.

### Riding apparel

Loose, fancy clothing can be uncomfortable and unsafe when riding a two-wheeler. Choose good quality two wheeler riding apparel.

### Know your limits

Ride within the boundaries of your own skill at all times. Knowing these limits and staying within them will help you avoid accidents.

### Warning

**Two wheeler safety starts with wearing a good quality helmet.** One of the most serious injuries that can happen is a head injury. Always wear an ISI approved helmet that should fit your head comfortably and securely. You should also have good quality goggles to protect your eyes and help your vision.

*To prevent or minimize accident, never consume alcohol or drugs before or during the operation of your vehicle. Even minimal consumption of these will affect the rider's ability to control the vehicle.*

## Posture

Proper vehicle riding starts with proper posture.

1. Keep your elbows relaxed and flexible.
2. Sit and adjust yourself on seat so that arms and shoulders are relaxed.
3. Look widely instead of gazing at one point.

## Warning

**One-hand riding is dangerous.** Keep both hands firmly on the handle bar and both feet securely on the floor board. Under no circumstances should both the hands be removed from the handle bar, as it is very dangerous.

**Avoid use of mobile phones while riding as it could lead to fatal accident.**

*Slow down to a safe speed before negotiating a corner. If this is the first time that you are riding a vehicle of this type, we suggest that you practice on a safe, open area to become thoroughly familiar with the operation of the vehicle.*

## Cornering

When cornering, centrifugal force works in a direction perpendicular to the direction in which the vehicle is moving. Centrifugal force increases in proportion with speed and the radius of the corner.

During cornering, reduce speed so as to lessen the effects of centrifugal force. By all means, avoid abrupt application of brake or sudden steering.

## Braking

For safe riding, it is very important to master the braking techniques.

1. Close / release the throttle.
2. Hold the vehicle upright as you apply the brake.
3. Progressive application of brake is safer.
4. Apply both the brakes. 'SBT' provides additional braking even when 'only rear brake' is applied, But applying 'both the brakes' helps you to use the full potential of the brakes.
5. Riding down hills, while cornering and wet roads, close throttle and come to a slower speed to avoid the loss of control over the vehicle due to skidding.

## Causes for poor braking

1. If the brake shoes / pads or drum / disc are worn out or if there is water or oil on them, sufficient friction does not develop and brakes do not work well.
2. Even when the brake works normally, if the road surface is wet or the tyre surface is worn-out, tyres do not take a firm hold on the surface, increasing the stopping distance.
3. Approximately 60% braking effect is from front brake. **Non-usage of front brake causes poor braking.**

## Warning

*As the vehicle speed increases, the stopping distance also increases progressively. Be sure that, you have sufficient distance between you and the vehicle or obstruction ahead of you.*

*Using only the front or rear brake is dangerous and can cause skidding and loss of control. **Apply both the brakes together and with great care on a wet road or other slippery surfaces.** Any abrupt braking on slippery or irregular roads can cause loss of rider control.*

## ACCESSORY INSTALLATION AND SAFETY TIPS

Use extreme caution while selecting and installing the accessories for your scooter.

The addition of **unsuitable accessories can lead to unsafe operating conditions.** Your friendly Dealer will assist you in selecting quality accessories and installing them correctly.

While selecting the accessories, make sure that the accessories **should not obstruct lighting, steering, suspension level and ground clearance.**

**Additional electrical equipments is not acceptable as it will void the warranty terms of the vehicle.**

## EMISSION CONTROL

All the TVS vehicles are tested in the factory for optimum fuel efficiency and CO levels. If the vehicle needs any adjustments, please consult nearest TVS Motor Company Authorised Main Dealer / Authorised Dealer.

While adequate care is exercised at the factory to ensure that the emissions are within the limits, it is essential for the owner to always maintain the TVS Jupiter 125 in good condition by getting it periodically checked and serviced by TVS Motor Company Authorised Main Dealer / Authorised Dealer so that the emission and fuel consumption levels are maintained as per norms.

### Crankcase emission control system

The engine of your TVS Jupiter 125 is equipped with a closed crankcase ventilation system to prevent discharging crankcase emissions into the atmosphere. Blow-by gas is returned to the combustion chamber through the air cleaner and the fuel system.

### Evaporative emission control system

TVS Jupiter 125 is equipped with an evaporative emission control system which consists of a canister and associated piping. This system prevents the escape of fuel vapors from the fuel tank.

## Warning

*If there is any abnormal jerk, startability issue are felt in the vehicle or noise due to sudden escape of gas during opening of fuel tank cap, immediately report to the TVS Motor Company Authorised Main Dealer / Authorised Dealer.*

## Note

***Your vehicle is tested and certified for emission which meets BS VI emission norms and is valid for initial 12 months from the date of purchase. Get your vehicle certified by the Government authorised emission testing station after initial 12 months of usage. And ensure to get vehicle certified on expiry of the certificate obtained.***

**VEHICLE IDENTIFICATION NUMBER**

The frame and engine serial numbers are the only means of identifying your vehicle from others of the same model and type. They are also required to assist your Dealer for ordering parts or referring to special information.



The frame serial number is stamped on the frame, at the rear end below the seat assembly. Open the seat assembly to read the frame number.



The engine serial number is stamped on the left side of the engine, at the bottom, near center stand mounting. See bottom to read serial number.



## LOCATION OF PARTS - HANDLE BAR

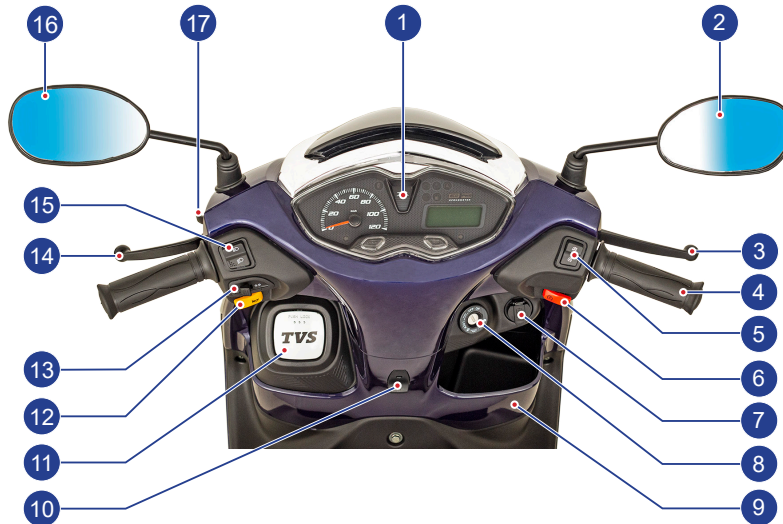

1. Speedometer assembly
2. Rear view mirror R\*
3. Right hand brake lever
4. Throttle grip
5. 'TVS intelliGO' switch
6. Electric starter switch
7. Smart phone charger\*
8. All in one lock
9. Glove box
10. Bag hook (front)
11. Fuel tank cap
12. Horn switch
13. Turn signal lamp switch
14. Left hand brake lever
15. High / low beam cum pass-by switches
16. Rear view mirror L\*
17. Parking brake

\* Mandatory and optional accessory will be charged extra

## LOCATION OF PARTS - VEHICLE LEFT SIDE



1. Gas filled adjustable rear shock absorber
2. Rear brake adjusting nut
3. Side stand
4. Pillion foot rest L
5. Caliper assembly front
6. Disc plate front
7. Pillion handle

## LOCATION OF PARTS - VEHICLE RIGHT SIDE



1. Front wheel axle nut
2. Bag hook (rear)
3. Cover front
4. Pillion foot rest R
5. Gauge oil level
6. Muffler assembly
7. Rear fender
8. Seat assembly

## LOCATION OF PARTS - VEHICLE FRONT & REAR



### FRONT

1. LED Head lamp
2. Head lamp focus adjuster
3. Turn signal lamp front LH
4. Turn signal lamp front RH
5. Throttle cable adjuster

### REAR

1. Turn signal lamp rear RH
2. Tail / brake lamp
3. Transmission oil level screw
4. Reflex reflector
5. Turn signal lamp rear LH

\* License plates are mandatory accessory will be charged extra

## ALL IN ONE LOCK

TVS Jupiter 125 comes with an 'All in one lock'. It has five positions and they are:

### 1. 'OFF' position

All the electrical circuits are turned 'OFF' in this position. Engine will not start. Key can be taken out.

### 2. 'ON' position

In this position, all the electrical circuits are turned 'ON' and the engine can be started now. Key cannot be removed in this position.

### 3. Steering 'LOCK' position

TVS Jupiter 125's steering can be locked in both 'left' and 'right' directions.



To lock the steering, turn the handle bar all the way to the 'left' or 'right'. Push the key 'IN', turn it to the 'LOCK' position and take out. All the electrical circuits are turned 'OFF' in this position. **Insert the key into the lock and turn it to 'OFF' or 'ON' position to unlock the steering.**

### Note

*When you switch on ignition key, the pump priming noise may be heard, which is normal. Avoid frequent 'SWITCH -OFF & ON' of ignition key, to avoid unnecessary run of fuel pump.*

*The speedometer back illumination, tail lamp and license plate lamp glow automatically once the ignition key is turned 'ON' without activating any other switches.*

### Caution

*Leaving the ignition cum steering lock in 'ON' position will drain the battery when the vehicle is not in use. switch 'OFF' and take the key out when the vehicle is not in use. For safety always lock the steering.*

### Warning

*Never attempt to move the vehicle when the steering is locked, you may lose balance.*

#### 4. Seat 'Unlock' position

Seat lock operation is inbuilt in 'All in one lock' of TVS Jupiter 125. To open the seat, keep the key in 'OFF' position and turn it to anticlockwise direction without pushing the key 'IN'.

To lock the seat again, press the seat at the rear end to its position till a 'Click' sound is heard.



#### 5. Fuel tank cap 'Unlock' position

Fuel tank cap lock operation is inbuilt in 'All in one lock' of TVS Jupiter 125. To open the fuel tank cap, keep the key in 'OFF' position, push the key 'IN' and turn it to clockwise direction. The tank cap opens automatically.

To close the fuel tank cap, press the cap at the front end to its position until a 'Click' sound is heard.



#### Note

While closing the fuel tank cap press at the dotted mark area of the cap for easy closing.

## SPEEDOMETER ASSEMBLY - SEMI DIGITAL



### 1. Turn signal indicator lamp left ( ← )

Flashes when the left side turn signal indication is activated.

### 2. Speedometer

Indicates vehicle speed in kilometers per hour.

### 3. Side stand indicator ( 🚩 )

The side stand warning indicator turns 'ON' along with the buzzer to alert you when the vehicle's side stand is deployed. The vehicle will not start in this condition.

### Note

If the side stand is deployed before starting the vehicle, the vehicle will not get started. And if the side stand is deployed with the engine running condition, the engine gets of automatically to ensure the safety.

If there is a error in the side stand sensor the indication will blink and the vehicle will not start. In such condition, please visit the nearest TVS Motor Company Limited Authorised Main Dealer / Authorised Dealer.

### 4. High beam indicator lamp

Glowes either when the head lamp high beam or the pass-by is activated.

### 5. Malfunction indicator lamp - MIL ( 🚗 )

MIL will be turned ON when the ECU detects a fault in the system and MIL will blink when the ECU detects a misfire\* in the engine.

**If the malfunction indicator lamp ' 🚗 ' is glowing continuously or blinking continuously\* when the engine is started, immediately contact the nearest TVS Motor Company Authorised Main Dealer or Authorised Dealer.**

\* Mis-firing detection is applicable only for OBD II vehicle.

## 6. ISG malfunction indicator ( )

ISG malfunction indicator will be turned 'ON' when the ISG detects a fault in the system.

If the ISG malfunction indicator is glowing continually after the self check of the speedometer, immediately contact the nearest TVS Motor Company Authorised Main Dealer / Authorised Dealer.

## 7. 'TVS intelliGO' ( )

Fuel is consumed unnecessarily when the engine is in idling (e.g. In traffic signals) as there is no useful output to the wheel. It contributes to emission and decreases mileage of the vehicle considerably.

To overcome this issue 'TVS intelliGO' system is introduced in TVS Jupiter 125 to automatically shut down the engine when it is kept idling for long and restart from stop condition by simply pressing the Brake and performing Throttle operation (open and close). **We recommend to use of this 'TVS intelliGO' system to improve the fuel economy and reduces emission.**

### Activation of 'TVS intelliGO' system:

'TVS intelliGO' system gets activated when the following requirements are satisfied,

1. 'TVS intelliGO' switch is in '  ' position

2. Engine is warmed up and
3. When the vehicle speed has crossed 5 kmph



When the vehicle meets the above condition, 'TVS intelliGO' system gets enabled and the intelliGO indicator '  ' in the speedometer glows continuously and informs you that the vehicle has entered intelliGO mode and the engine will stop automatically at upcoming vehicle idling condition.

Once the vehicle enters the idling condition, the intelliGO indicator starts blinking instead of glowing and the engine stops after predetermined time.

Now, the intelliGO indicator starts glowing again during the engine stop to indicate you that the vehicles has been stopped due to 'intelliGO' system.

**The vehicle stopped by 'TVS intelliGO' system can be restarted at any time within 5 mins from the stop of the vehicle by intelliGO feature in a simple way of applying brake and open & closing throttle trigger.**

### Deactivation of 'intelliGO' system:

1. 'intelliGO' system will be deactivated if the intelliGO switch is positioned at '  ' position or If the ISG malfunction indicator '  ' or MIL indicator '  ' is 'ON'.



2. If there is 5 unsuccessful start of the vehicle either by electric start or by intelliGO restart method in one ignition key 'ON' cycle.
- 3. If the vehicle is not restarted within 5 mins from the idle stop condition.**
4. During low battery condition the intelliGO system will be deactivated.

### Note

*Ensure that the brake free play is adjusted and it is within the limit for the proper working of 'TVS intelliGO'.*

*Vehicle can be started at any point of time using 'electric start' when the engine is stall condition and the ignition key in 'ON' condition.*

*'TVS intelliGO' switch can be activated / deactivated at any point of time.*

*If vehicle is stopped by 'TVS intelliGO' system, and the 'TVS intelliGO' switch is toggled from 'ON' to 'OFF' position and back to 'ON' position, the intelliGO system will be deactivated and the vehicle can be restarted only by the 'electric start'.*

### **Prolonged idling:**

When vehicle is in idling with the engine temperature high enough to maintain stable engine idling rpm and the intelliGO switch is in '(A)' position, then the intelliGO will be activated.

When 'TVS intelliGO' is enabled, the intelliGO lamp glows for 5 seconds and then blinks for predetermined time and then the engine stops. The intelliGO lamp glows continuously once the vehicle has stopped due to intelliGO system.

### **8. Economy and power indicators**

Eco indicator (green lamp) indicates that the vehicle is running in economy mode which gives better fuel economy.

Power indicator (amber lamp) indicates that the vehicle is running in power mode which results in reduced fuel economy.

### Note

*Always ride the vehicle in 'Economy mode' for better fuel efficiency.*

*If the battery voltage is very low, 'Power mode' lamp will glow once you switch 'ON' the ignition key. Electric starter will not work in this condition. Contact TVS Motor Company Authorised Main Dealer / Authorised Dealer.*

### 9. Low fuel warning indicator lamp ( ) \*\*

'Low Fuel Warning Indicator (LFI)' is a safety indicator to caution you to fill the petrol as soon as possible.

### 10. Turn signal indicator lamp right ( )

Flashes when the right side turn signal indication is activated.

### Caution

**Minimum 1.5 liter of fuel should be maintained in the fuel tank to avoid engine switch OFF / damage to fuel pump which leads to replacement of pump without warranty.**

\*\* 'LFI' is not a mileage calculating medium and it should not be used for measurement of fuel consumption

### 11. Multi function display

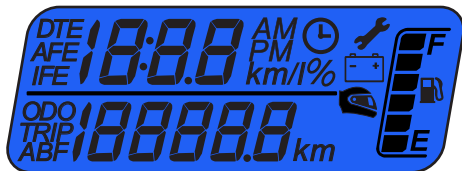

### 11a. Odometer

Odometer registers and displays the total distance covered by the vehicle in kilometers. Set the display in 'ODO' mode to know the reading.

ODO **657** km

### 11b. Trip meter

In ODO mode, press 'Mode' switch once or twice to enter 'TRIP A' or 'TRIP B' meters respectively.

TRIP A **152.1** km

TRIP B **52.3** km

Trip meter registers and displays the partial distance covered in kilometers. The digit after the dot mark denotes one tenth of a kilometer. Set the display in 'TRIP A' or 'TRIP B' mode to know the reading.

Provision to measure two different distance 'TRIP A' or 'TRIP B' is provided for the users to use as per their convenience.

### Trip F\*



This function shows the distance traveled after the low fuel indication '  ' is turned 'ON'. The last segment of the fuel level indicator starts blinking while the 'Trip F' function is 'ON'.

'Trip F' will activate once the low fuel indication is 'ON' and starts counting from 0.0 km. If the fuel level remains in minimum safe (reserve) level, the reading will be saved even after the ignition 'OFF'.

The 'Trip F' meter stops counting and display move to 'ODO' once the fuel is filled above minimum safe level (reserve level) which is indicated by at least 2 bars in the fuel level indicator.

**Please remember that the 'Trip F' meter cannot be activated or deactivated manually and can't be reset.**

\* 'TRIP F' can be accessed incase of low fuel only.

On every ignition 'ON', 'Trip F' meter will get enabled automatically until fuel level raises above minimum safe level. 'Trip F' can be accessed using the 'Mode and Set' switch operation.

### 11c. Helmet icon

With every ignition 'ON', Helmet icon '  ' blinks for 10 seconds on the left side of the multi function display to alert you to wear a safety helmet.

### 11d. Fuel level indicator (fuel gauge)

Digital bars indicates the approximate fuel quantity available in fuel tank. There are six bars to indicate the fuel quantity available in the tank. All the six bars will be displayed when the fuel in the tank reaches above 5.1 liters approx.



### Note

Please note that, the fuel level indicator is not a mileage calculating medium and it should not be used for calculating the mileage.

When the fuel reaches half tank (3 liters approx.) the fuel gauge displays only three bars as shown.



When The fuel reaches minimum safe level (1.35 liter approx.), the last bar of the fuel gauge starts blinking, low fuel indicator (  ) starts glowing and 'Trip F' meter starts counting from 0.0 km as explained in the previous page. Fill fuel immediately.



### 11e. Low battery indicator

An icon with battery symbol '  ' glows when the battery charge is too low. Contact your nearest TVS Motor Company Authorised Main Dealer / Authorised Dealer.

### Caution

*Start ability of vehicle using electric start will be difficult when the low battery indication is 'ON'. 'intelliGO' feature will be disabled.*

### 11f. Service reminder

If the service is due, whenever the ignition switch is turned 'ON', an icon with spanner symbol '  ' blinks for 10 seconds after the self-test cycle of speedometer and continues to glow till the vehicle is serviced and reset. Get the vehicle serviced at TVS Motor Company Authorised Main Dealer / Authorised Dealer.

### 11g. Digital clock

Indicates the time in 12 hour time format.



### Note

*Service reminder indicator lamp works only based on the distance (km) covered by the vehicle. This is only a reminder indicator. Customers are advised to keep track and follow the service schedule.*

### 11h. Distance to empty (DTE)\*

Indicates the approximate distance that can be covered by the vehicle with the available fuel in the tank.

DTE **60** km

### 11i. Average fuel efficiency (AFE)\*

Display approximate Average Fuel Economy since AFE is reset.

AFE **45.3** km/l

### 11j. Instantaneous fuel efficiency (IFE)

Display the current fuel economy of the vehicle if the speed is above 10 kmph.

IFE **52.3** km/l

### Note

If any of the features is displayed as '-- Km/l' or '-- Km', contact TVS Motor Company Authorised Main Dealer / Authorised Dealer.

\* Subjected to vehicle driving condition

## MODE AND SET SWITCH



The multifunction display of the speedometer has various functions like 'ODO', 'TRIP A', 'TRIP B', 'TRIP F#', 'DTE##', 'AFE', 'IFE' and 'CLOCK'.

These functions are displayed in two segments named upper and lower segments of the multifunction display.

The upper segment consists of 'DTE##', 'AFE', 'IFE' and 'CLOCK'.

The lower segment consists of 'ODO', 'TRIP A', 'TRIP B' and 'TRIP F#'.



The sequence of Mode switch operation to change between various function is shown below:

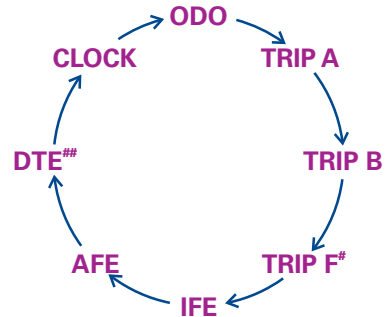

\* 'TRIP F#' can be accessed only when the low fuel indicator is ON.

\*\* 'DTE' cannot be accessed when fuel in the tank is in full condition or in reserved condition.



## Note

Please make a note that when the display in lower segment is in 'ODO / TRIP A / TRIP B / TRIP F' mode, only CLOCK will be displayed at the upper segment of the multifunction display.

Similarly, when the display in upper segment is in 'DTE / AFE / IFE / CLOCK' mode, only ODO will be displayed in lower segment of the multifunction display.

## Setting the digital display

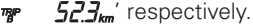
Turn on the ignition.

- When the display is in 'ODO' mode, press the Mode button once or twice to enter Trip A '' or Trip B '' respectively.
  - To reset any of the trip value, press and hold the Set button for a few seconds while the display is in 'TRIP A' or 'TRIP B' respectively.
- When the display is in 'Trip B' mode, press the Mode button once to enter IFE '.
- When the display is in 'IFE' mode, press the Mode button once to enter AFE '.

  - To reset the AFE while ensuring the display is in '' , press and hold the Set button for a few seconds.

- When the display is in 'AFE' mode, press the Mode button once to enter DTE '.
- When the display is in 'DTE' mode, press the Mode button once to enter 'Clock'.

## Digital clock setting

- Ensure that the upper segment of multifunction display is in 'CLOCK' mode and lower segment of multi function display is in 'ODO' mode.
- Long press the 'Set' switch to enter the clock setting mode. Once the clock enters its setting mode, the hour digits of the clock starts blinking.
- Press the 'Mode' switch to increase the hours while the hour digits are blinking.
- On pressing the 'Set' button again the hours gets set and the minute digits starts blinking.
- Now, press the 'Mode' button to increase the minutes while minute digits are blinking.
- Once again press the 'Set' button so the minutes of the clock is set and the hours format 'AM' or 'PM' starts blinking.
- Press the 'Mode' button to change the hour format either to set 'AM' or 'PM'.
- Press the 'Set' button once again to set clock.

## LED HEAD LAMP

TVS Jupiter 125 comes with a LED head lamp which glows automatically once the engine is started. The head lamp beam (high / low) can be controlled by changing the beam control switch position to 'Low' or 'High' beam.





## HANDLE BAR LEFT SIDE

### 1. Horn switch

Press the switch '  ' to operate the horn.

### 2. Turn signal lamp switch

Slide the turn signal lamp switch to the left '  ' or right side '  ' to operate respective turn signal lamps (LH / RH). Press the switch to turn 'OFF'.

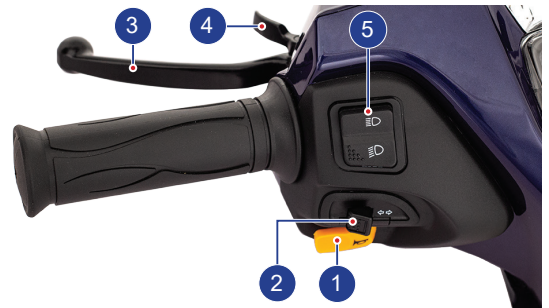

### Warning

Always use the appropriate turn signal lamps when you intend to change lanes or take turns. Be sure to switch 'OFF' it after negotiating the lanes or turns.



### 3. Left hand brake lever (SBT brake lever)

Synchronised Braking Technology (SBT) can be operated by pressing the left hand brake lever gently towards the handle grip.

SBT technology helps to operate both front and rear brakes by distributing the force optimally between the two braking system.

### 4. Parking brake (rear brake lock lever)

Brake lock protects your scooter from rolling-off, when parked on side stand (or) helps you relax while waiting in a long traffic signal (or) a slope.

To activate brake lock, press the brake lever almost half towards the grip and hold, then press the parking brake lever to the maximum and release the brake lever slowly. Ensure the brake is locked properly. Pressing the brake lever further releases the brake lock automatically.



#### **Warning**

*Since your vehicle is fitted with SBT brake system it is essential to maintain the brake system in good condition. Adjust the brakes system at regular intervals for the proper working of SBT.*

*Ensure to release the brake lock before riding the vehicle.*

### 5. High/low beam cum pass-by switch

**The head lamp glows automatically once the engine is started. Only the head lamp beam (high / low) can be controlled by pressing the 'high / low beam' switch.**

Press the switch towards '  ' to operate head lamp high beam or press it towards '  ' to operate head lamp low beam.

TVS Jupiter 125 has a combined switch for head lamp 'high / low beam' and 'pass-by' operation. To operate the pass-by, keep the switch in low beam position and gently press & release the switch. This makes the head lamp high beam to flash and signal the approaching vehicle. The pass-by signal can be used while overtaking during day time.

#### **Warning**

*Use appropriate head lamp beam 'high / low' as per the traffic and road conditions for your safety and to avoid inconvenience to other riders. It is strongly recommended to ride the vehicle in 'low beam' during day.*

## HANDLE BAR RIGHT SIDE



### 1. 'TVS intelliGO' switch

To activate the 'TVS intelliGO' system, set the intelliGo switch to 'A' position. The intelliGo indicator 'A' of the speedometer glows for 2 seconds on activation of intelliGo system.

To deactivate 'TVS intelliGO' system, set the intelliGo switch to 'A' position.

### Note

Refer page No. 26 for intelliGo feature details.

### 2. Right hand brake lever

Front brake system can be operated by pressing the right hand brake lever gently towards the throttle grip. The brake lamp glows on application of either right hand or left hand brake lever.

### 3. Throttle grip

Engine speed is controlled by the rotation of the throttle grip. Twist it towards you to increase the engine speed and twist it away from you or release it to decrease the engine speed.

### 4. Electric starter switch

Press the starter switch '⚡' to start the engine electrically along with the application of either of the brake and side stand in retracted condition.

### Caution

*It is not recommended to add any additional throttle grip (cover).*

## FUEL TANK\*\* CAP

Fuel tank is located at the front end of the vehicle below the handle bar.

To open the fuel tank cap, follow the procedure given in the page No. 24. To close the cap, gently press the cap in its position and ensure locking by hearing 'Click' sound.



\*\* The fuel tank is not a measuring instrument and the capacity of the fuel tank may slightly vary from the indicated capacity.

### **Caution**

*Ensure that the fuel gun is inserted fully into the tank neck while refueling.*

*Whenever refueling the scooter, fill only the recommended quantity of fuel.*

*While refueling, avoid spillage of petrol on the tyre. If fuel spills on tyre, the tyre will lose its grip on the road. Ensure to close fuel tank cap without fail to avoid fuel spillage.*

### **Warning**

*Never refill fuel near open flame. Do not smoke while refueling. Do not use cell phones while refueling.*

### **Note**

*While closing the fuel tank cap press at the dotted mark area of the cap for easy closing.*

## EFFORTLESS E-Z CENTRE STAND

TVS Jupiter 125 is equipped with a effortless centre stand. The centre stand (1) has a pivoted flexible spring loaded lever arm (stand extension) (2) to increase the lever ratio, which enables parking on centre stand effortlessly and very conveniently.

To place the vehicle on centre stand, hold the handle bar left grip with left hand. Place your foot firmly on the centre stand extension (2) and press.



### **Caution**

Never sit on vehicle when it is supported by stands. Always park the vehicle on a flat, firm surface.

## SIDE STAND

Side stand can be operated by sitting on vehicle with your left foot by pushing it away from the vehicle till it stops.



### **Note**

*If the side stand is deployed before starting the vehicle, the vehicle will not get started. And if the side stand is deployed with the engine running condition, the engine gets of automatically to ensure the safety.*

*If there is a error in the side stand sensor the indication will blink and the vehicle will not start. In such condition, please visit the nearest TVS Motor Company Limited Authorised Main Dealer / Authorised Dealer.*

## TOOL KIT AND FIRST AID KIT

To assist you in performing certain aspects of periodic maintenance and emergency repairs, a tool kit is supplied along with the vehicle and it is located below the seat base. To access the tool kit, seat need to be opened. Follow the procedure given in the page No. 24 for the seat opening procedure.



### **Caution**

*It is recommended to use the tool kit in case of any emergency only. It is always advisable to take your vehicle to TVS Motor Company Authorised Main Dealer / Authorised Dealer.*

The tool kit consists one number each of the following. Ensure the contents of the tool kit.

10x12 mm spanner

Combination screw driver bit

Screw driver handle

Tool bag

### **Warning**

*Do not remove the tool kit and first aid kit from the vehicle. Always ensure to keep them along with the vehicle. Ensure the first aid equipments are changed periodically based on the date of expiry.*

## UTILITY BOX

Utility box is located below the seat. Lift the seat by unlocking the seat lock as explained in the page No. 24 to access the utility box.



## Caution

*Utility box has the storage space of 33 liters.*

*Do not carry perishable items inside the utility box. It is not fully sealed. Do not allow / spray water to get inside the utility box. Take care not to spill petrol or oil into the utility box.*

*Do not keep heat-sensitive items inside as it may get hot on long rides. **Do not keep valuable items inside the utility box when leaving the vehicle unattended.***

## Warning

*Operating the TVS Jupiter 125 overloaded will hamper the riding stability and may lead to loss of control. Hence, it is advisable to carry the recommended amount of load only.*

## GLOVE BOX FRONT

TVS Jupiter 125 is provided with glove box front. Which has 2 liter storage capacity and used to hold your mobiles while charging or hold a small bottle.



### Warning

Ensure that your mobile or any material stored is safely held with in the glove box front while riding your TVS Jupiter 125.

Also recommended not to keep your belongings when the vehicle is parked unattended.

## BAG HOOKS

There are two bag hooks provided with your scooter to carry light luggage like carry bags weighing upto 3 kg. One hook is located below handle bar on the rear panel.

Just pull out the hook from the top (A) to hang your luggage. Push back the hook once it is free.

Similarly, the other one is located on the cover front below front end of the seat assembly. Pull out the hook from its position. Open the top lid and hang your cargos. Lid will get close automatically. Push back the hook to its original position once it is free.



## Caution

Care should be taken not to attach the luggage which hangs out of your scooter. Please note that the luggage attached to your scooter should not interfere your feet movement.

## SMART PHONE CHARGER\*

This smart phone charging socket enables you to charge your smart phone when you are traveling.

This socket is located below the handle at right side of the vehicle. Please go through the operating manual of the mobile phone and use a suitable USB cable recommended by the mobile phone manufacturer for that particular model. Please follow the guidelines provided for the proper usage of the socket:

### DO's

1. Ensure that no water enters into the socket by closing the USB flap properly.
2. Use only mobile phone company's authorized USB cable for mobile charging.
3. Do make sure the flap is not damaged while opening / inserting the USB cable.

\* Mandatory and optional accessory will be charged extra

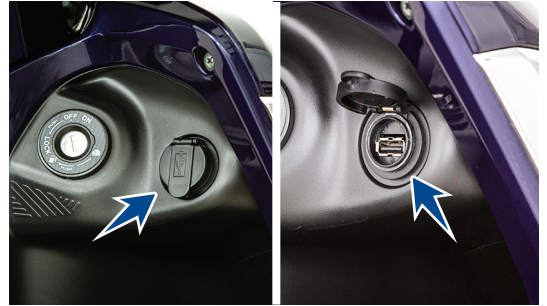

### DON'Ts

1. Do not leave the USB charging flap open / partially closed.
2. Do not attempt to use / charge any other device, other than one mobile phone at a given time.
3. Do not try to force the USB connector in, check if it is inserted in the appropriate direction, to prevent damage.
4. Do not charge your mobile when the engine is in 'OFF' condition.
5. Do not use other device, this port is for charging mobile phones only.



 **Caution**

Secure your mobile phone properly during charging and protect it from any liquid, dust etc.

The charging time of the mobile may vary, depending on the mobile battery's state of charge.

The flap in the unit has been designed to prevent water entry and it is not replaceable. **No warranty for charger incase of flap damage.**

**UTILITY BOX LIGHT\***

TVS Jupiter 125 comes with utility box light which is located in the utility box of your vehicle (refer page no. 24 for opening seat). The light glows once the seat is opened and gets 'OFF' when the seat closed automatically.

 **Note**

Ensure that the seat is fully closed to avoid battery drain due to continuous glowing of utility box light.

\* Mandatory and optional accessory will be charged extra

## PRE RIDE INSPECTION

Check the following items before riding

ITEM	WHAT TO CHECK FOR
Engine oil	Availability of oil upto the level (page no. 57)
Transmission oil	Availability of oil upto the level (page no. 58)
Fuel	Enough fuel for the planned distance of running
Tyres	Correct pressure (page no. 66) Adequate tread depth / No cracks or cuts.
Battery	Proper working of electric starter, horn, fuel gauge, pass-by, brake lamp, tail lamp, speedo back illumination, license plate lamp and turn signal lamps.
Lighting	Proper working of head lamp high / low beam and high beam indicator
Steering	Smooth movement / No play or looseness
Throttle	Correct free play of cable / Smooth operation
Brakes	Availability of brake fluid upto the level (page no. 59) Correct front and rear brake lever play (page no. 60 & 63)
Wheels	Free rotation
Malfunction indicator	Turned OFF after the engine is started (page no. 25)
ISG malfunction indicator	Turned OFF after the Ignition 'ON' and engine is started (page no. 26)

### **Caution**

*Do not switch 'ON' the ignition without minimum level fuel in tank. It will cause damage to the fuel pump.*

## STARTING THE ENGINE

Ensure the availability of fuel in the fuel tank. Insert the control key into the ignition cum steering lock and turn it to the 'ON' position. In side side retracted condition, apply any one of the brake and press the electric starter switch to start the vehicle.

Press the start button (one touch noiseless start) without applying the throttle. As soon as the engine starts, release the start button. The engine will not start if the throttle is opened.

### Setting the vehicle in motion

1. Twist the throttle grip slowly towards you and simultaneously release the brake lever gently and smoothly. The vehicle will start moving forward.
2. As the vehicle picks up speed, increase the throttle slowly.

### Stopping and parking

1. Close the throttle completely and apply both the brakes simultaneously.
2. Turn the ignition 'OFF'.
3. Park the vehicle on a firm, flat surface.
4. Lock the steering and take out the control key.

### Warning

*Do not raise the throttle rapidly so the vehicle will move forward suddenly and lead to loss of control.*

*Reduce speed to a safe limit before turning / cornering. Do not apply brake while turning / cornering.*

### Caution

*Do not open excessive throttle when the vehicle is parked. It leads to overheating of engine and damage to the internal components.*

## FUEL RECOMMENDATION

Use only BS VI petrol with minimum RON 91. BS VI petrol containing upto 20% of ethanol by volume can be used.

Higher ethanol content in petrol can lead to

- degrade plastic and rubber components of fuel system and vehicle parts
- cause corrosion damage to metal parts like fuel tank, etc
- result in startability & drivability issues
- decrease fuel economy

Ethanol absorbs water very easily, resulting fuel separation. Extra care shall be taken to prevent moisture entry into fuel tank while filling ethanol blended petrol and water washing of vehicle.

Painted parts (viz. panels, covers) shall not come in contact with ethanol blended fuels.

Manufacturer is not responsible for any warranty issues that results from using ethanol blend in excess of 20% by volume in petrol.

In case of any abnormalities observed due to use of ethanol blended fuels, customers are advised to use a different fuel station / brand for standard E20 fuel or contact authorised service centres.



## Caution

*Never mix oil in petrol in the fuel tank. Always fill fuel from the reputed and reliable fuel stations.*

## CHECKS AND TIPS FOR IMPROVING FUEL ECONOMY

### Regular checks

Carry out the periodic maintenance checks as specified in this manual (page no. 49).

Regular maintenance checks will save fuel and ensure trouble-free, enjoyable and safe riding besides keeping environment clean.

### Spark plug

A dirty or defective spark plug leads to wastage of fuel due to incomplete combustion. Inspect and clean the spark plug only if necessary. Replace the spark plug every 12000 kms (1 year). Always use recommended spark plug only.

### Air cleaner element

A dirty air cleaner element restricts airflow and increases fuel consumption. Replace the element every 12000 kms.

Since paper filter is used in your scooter it is not recommended to clean the filter. Replace the filter incase of any abnormalities.

### Engine oil and Transmission oil

Dirty or less engine oil increases friction between various parts of the engine and reduces the engine life, thereby increases the fuel consumption.

Running with low transmission oil will cause damage to the gears and bearings. **Regularly inspect the engine oil and the transmission oil for correct level and top-up if necessary. Get it replaced at regular intervals as per the maintenance schedule.**

### Fuel leak

Inspect and arrest fuel leaks if any from tank and fuel lines. Loss of fuel due to leak may drain the fuel tank completely.

### Evaporation

Vehicle parked in the hot sun leads to wastage of fuel through evaporation. Also, lower fuel levels in the tank will have increased evaporation and condensation of moisture inside. Ensure to close fuel tank cap after every filling. If the fuel tank cap kept open for long time, it leads to safety issues and fuel loss.

### Tyres

Low tyre pressure has adverse effect on the vehicle. The **drag on the vehicle** increases resulting in decreased fuel economy. Further more, handling may be adversely affected.

Inspect the tyre pressure regularly (weekly) and inflate it to the recommended pressure (refer page no. 66). Never use tyres which are worn beyond the permissible limit.

### Wheel freeness

Inspect and ensure the wheel freeness by rotating the wheel at least once in a week to avoid wastage of fuel.

### Avoid frequent braking

Anticipate corners and slopes as well as the traffic conditions. **Unnecessary and frequent braking will reduce the fuel economy. Never accelerate and apply brake simultaneously.** It leads clutch shoes wear and wastage of fuel.

### Note

*The on-road mileage of TVS Jupiter 125 is dependent on several factors like road condition, quality of fuel, riding speed, operation of brake, tyre inflation, maintenance / timely servicing of vehicle, load etc. and hence will differ from the mileage given under standard test conditions such as made in recognised institutes.*

## MAINTENANCE SCHEDULE

The maintenance schedule indicates the intervals between periodic services. At the end of each interval, be sure to inspect, check, replace, adjust, lubricate and service as instructed. If the maintenance is not done periodically, it will result in rapid wear and severe damage to the vehicle. If the vehicle is used under high stress conditions such as continuous full throttle operation or if used / operated in dusty climate, certain jobs should be performed more often to ensure reliability of the vehicle. Cylinder head, steering components, suspension and wheel components etc., are key items and require very special and careful servicing. TVS Motor Company Limited strongly recommends that the jobs as per the maintenance schedule be performed by your TVS Motor Company Authorised Main Dealer / Authorised Dealer.

Periodic inspections may reveal one or more parts that may need replacement. Whenever replacing parts on TVS Jupiter 125, it is recommended that you use only the TVS Motor Company Genuine parts.

### **Caution**

*Proper running-in and maintenance are mandatory for making certain that your vehicle is reliable and gives optimum performance at all times. Make sure that the periodic maintenance is performed thoroughly in accordance with the instructions given in this owner's manual.*

*In more dusty areas, the air filter element requires early replacement than the mentioned kilometers to avoid costly damages to the engine.*



## PERIODIC MAINTENANCE SCHEDULE (months or km whichever occurs earlier)

SERVICE km PERIOD FROM DATE OF SALE		PRE RIDE CHECK	FREE SERVICE			AFTER FREE SERVICE	REMARKS
			1st 500 ~ 750 30 ~ 60 days	2nd 5500 ~ 6000 6 months	3rd 11500 ~ 12000 12 months	Every 6000 km / 6 months	
ITEMS	ACTIVITY						
Engine oil / Oil filter (strainer)	Replace or Inspect and top-up	-	R / C	R / C	R / C	R / C	Clean strainer
Transmission oil	Replace or Inspect and top-up	-	-	-	-	-	Replace every 24000 km
Spark plug	Inspect and clean or Replace	-	I	-	R	-	Inspect and clean if required. Replace every 12000 km
Air cleaner element	Replace	-	-	-	R	-	Replace every 12000 km
Tappet clearance	Inspect and adjust	-	I	I & A	I & A	I & A	Inspect for any abnormal noise, starting trouble and adjust if required
Drive belt, CVT rollers and clutch shoe	Replace	-	-	-	-	-	Replace every 24000 km
Cover variator	Inspect, clean and lubricate	-	-	I, C & L	I, C & L	I, C & L	
Front and rear suspension	Inspect for proper functioning	-	-	I	I	I	
Evaporative emission control system	Inspect	-	-	-	-	-	Every 18000 km
Throttle cable / grip	Inspect, clean, lubricate and adjust	-	-	I, C, L & A	I, C, L & A	I, C, L & A	
All fasteners	Inspect and tighten	-	I	I	I	I	Tighten if required
Steering smooth operation / play	Inspect, adjust and lubricate	-	-	-	I & A	-	Inspect and adjust Lubricate if required

Contd...

SERVICE km PERIOD FROM DATE OF SALE		PRE RIDE CHECK	FREE SERVICE			AFTER FREE SERVICE	REMARKS
			1st 500 ~ 750 30 ~ 60 days	2nd 5500 ~ 6000 6 months	3rd 11500 ~ 12000 12 months	Every 6000 km / 6 months	
ITEMS	ACTIVITY						
All bulbs, horn and switches working	Inspect for proper functioning	-	-	I	I	I	
Head lamp beam (focus)	Inspect and adjust	I	-	I	I	I	Adjust if required
Battery Voltage (recharge if required)	Inspect	-	-	I	I	I	Through diagnostic tool or at battery terminal
Brake effectiveness / play	Inspect, adjust & lubricate at cable ends	I	I, L & A	I, L & A	I, L & A	I, L & A	
Brake cam	Clean and lubricate	-	-	C & L	-	-	At 6000 km and every 18000 km thereafter if necessary
Wheels /Tires	Inspect	I	-	I	I	I	Set tyre pressure if required
Brake fluid <sup>#</sup>	Replace or Inspect and top-up	I	-	I	I	I	Replace at 21000 km or 2 years whichever occurs earlier
Brake hose <sup>#</sup>	Replace or inspect		-	I	I	I	
Master cylinder cups <sup>#</sup>	Replace		-	-	-	-	Replace at 18000 km
Disc brake SBT cable play <sup>#</sup>	Inspect and adjust	I	I & A	I & A	I & A	I & A	
MIL codes	Inspect	I	-	I	I	I	Connect ride scan tool if MIL glows in speedometer Check and clear DTCs

R - Replace; I - Inspect; T - Top up; C - Clean; A - Adjust; L - Lubricate; TI - Tighten

<sup>#</sup> Applicable only for Disc Brake version



## RECOMMENDED LUBRICANTS

APPLICATION	QTY	MANUFACTURER	BRAND
Engine oil	700 ml	TVS Motor Company	TVS TRU4 SKUUTA oil (SAE 10W30 API-SL, JASO MB)
Transmission oil	120 ml	-do-	-do-
Front fork oil	92 ± 1 ml / leg	IOC	Gabriel Premium front fork oil
Disc brake fluid <sup>#</sup>	-	TVS Girling	DOT 3 / DOT 4
Grease	-	Bharat petroleum IOC Bechem Kluber Lubrication	MP Grease No. 3 Servo Gem No. 3 Bechem Premium grade 3 Kluber Centoplex 2

<sup>#</sup> Applicable only for Disc Brake version

## SELF - MAINTENANCE PROCEDURES

### MAINTENANCE FREE (MF) Battery

Battery is located at the front of vehicle inside the front panel. This panel must be removed to access the battery. Follow the procedure for front panel removal:

1. Remove the front panel mounting screws shown in the figure (2 nos.).
2. Gently pull out the front panel by dislocating its lugs while taking care not to damage the mounting lugs.
3. During reassembly reverse the removal procedure.



Since the maintenance free battery is fitted in your vehicle it is not necessary to top-up with the distilled water. But to ensure the battery performance and long life, follow the steps given below:

Check the battery voltage as per the schedule. If the voltage is less than 12.4 volts, charge the battery using **recommended MF battery charger** at TVS Motor Company Authorised Main Dealer / Authorised Dealer.

1. Adding any additional electrical accessories other than TVS Motor Company Limited recommended ones, may lead to disqualification of warranty coverage.

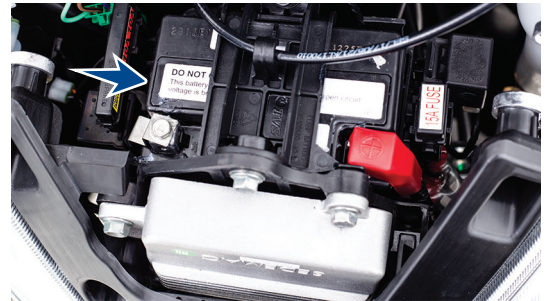

2. While connecting the terminals, observe the correct polarity. Connect the red wire to the '+' terminal and black wire to the '-' terminal of the battery.
3. Petroleum jelly must be applied at terminals to prevent it from corrosion.
4. In case of any abnormality or for removal of battery from the vehicle, contact TVS Motor Company Authorised Main Dealer / Authorised Dealer.

**Caution**

*Never check the battery charge by shorting the terminals.*

*Always connect the positive terminal first (red wire) and then negative (black wire) to avoid sparking.*

*The inversion of the battery wires can damage the battery and the electrical system.*

*# To be done by skilled personnel*

**Recommendations to maintain battery health during prolonged parking conditions**

While your vehicle is parked for prolonged duration, battery continues to discharge and if left unattended can get completely discharged. It is recommended to ride the vehicle for minimum 60 km every week to keep the battery in healthy condition. This could be at a stretch in one ride or several rides during the week. The vehicle speed will vary during the ride but an average speed of minimum 30 kmph will be helpful to ensure proper battery charging. Use kick-starting, if available, to conserve battery charge during such period. This is only a recommendation to maintain battery charge and regular service schedules must be followed to maintain your vehicle in good running condition.

The following are recommendations to users regarding battery maintenance before, during and after long storage of battery:

**1. Before storage**

- a. Store the battery only after fully charging it.
- b. Battery fuse to be disconnected and stored safely. This will reduce the sleep mode current and hence enhance storage life of battery.#

- c. Alternatively, battery connecting wires (positive and negative wires) can be disconnected and fasteners can be secured with battery terminals.#

## 2. During storage

- a. Store it at room temperature or lower.
- b. Store the vehicle in the shade and protected from rain and cover the vehicle to prevent rodents from entering and damaging the wires.

## 3. After storage

- a. Connect the wires and fuse, if disconnected earlier, with ignition switch in OFF position\*
- b. Start the vehicle by kick starting (if available).

(Above recommendations do not consider storage effects on other systems such as induction and fuel systems and wheels).

### Periodic maintenance of Batteries:

- Keep top of battery clean.
- Check cables, clamps, and case for obvious damage or loose connections.
- Clean terminals and connectors as necessary. Recharge battery if voltage is below 12.4 Volts.

- Valve Regulate Lead Acid (VRLA) / Lead Acid batteries are prone to water damage. Any water entry, through vents or otherwise; will result in irreparable damage to the battery or the vehicle.

### Warning

*Battery develop explosive gases. Keep it away from heat sources. If charging is required the battery must be charged in well ventilated area.*

*Unusable battery must be disposed in environment friendly manner. Do not discard it with household trash. Handover the battery to the battery dealers or to a recycle center that accept used battery.*

### Caution

*Never operate the vehicle with discharged battery as it may damage electrical components.*

*Do not push start the vehicle, use a good battery to start the vehicle.*

*# To be done by skilled personnel*

## FUSE

Non-working of electrical systems may be due to safety fuse failure. Short circuit or overload in the electrical system are the main causes for fuse failure. There are two fuse cases containing one blade type fuse (15A) and two mini fuses (15A & 10A) located near the battery. Follow the procedure given below for inspecting and replacing the fuse.

1. Turn 'OFF' the ignition.
2. Remove the front panel as explained earlier.
3. Take out the fuse cases located near from the battery one by one.
4. Open the fuse cases and take out the fuse.

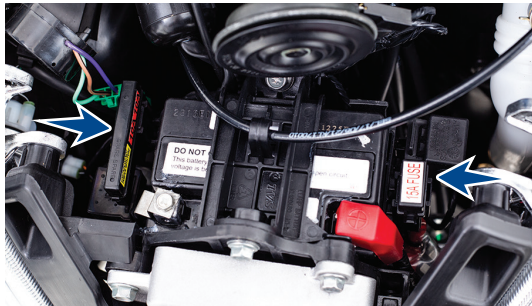

5. Inspect the fuse for failure. If found blown, replace it with a new (additional fuses are provided in the wiring harness itself in a pouch or provided inside the fuse case itself).
6. Close the fuse case and re-fix it into the battery box.
7. Turn 'ON' the ignition switch and check for proper functioning of electrical systems. In case the fuse fails again, consult the nearest TVS Motor Company Authorised Main Dealer / Authorised Dealer.

Good Fuse

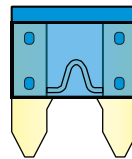

Blown Fuse

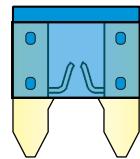

### Caution

Do not use the vehicle by **shorting the wires without fuse**. This may result in overheating of electrical items / wiring and may result in fire. Do not use fuse of higher amperage than specified for the safety of electrical system.

## SPARK PLUG

To access the spark plug, the cover front has to be removed. Follow the procedure to remove the cover front.

1. Open the seat and remove the top mounting screws (A) from both the sides of cover front.
2. Remove the bottom mounting screws (B) of cover front.
3. Gently pull out the cover front by dislocating its lugs.
4. Clean the dust and mud around the spark plug mounting to avoid falling inside the cylinder.

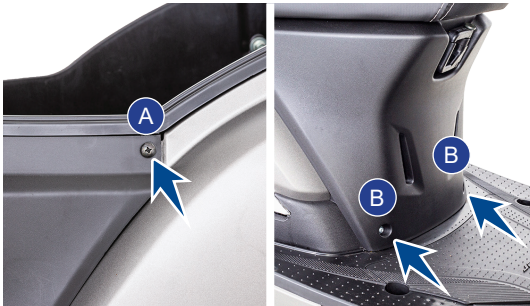

5. Pull out the suppressor cap from spark plug. Using the spark plug spanner, remove the spark plug.

A spark plug with heavy carbon deposits will not produce strong sparks. Hence, only if necessary, clean the carbon deposits from the spark plug with a small wire brush or spark plug cleaning tool.

Inspect the spark plug electrodes (A) and (B) for any corrosion. If found any, replace the spark plug with a new. Inspect the spark plug gap visually (1.0 ~ 1.1 mm). If found more, replace the spark plug with a new one.

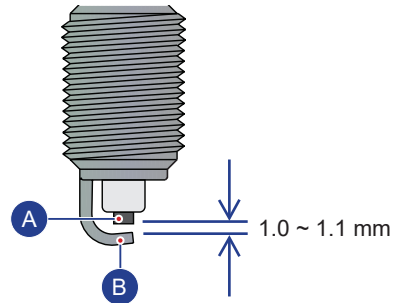

After cleaning and checking the gap, reinstall the spark plug and tighten by hand to avoid cross threading. Finally tighten using spark plug spanner. Do not over tight or corss thread the spark plug. After reassembling the plug fix bakc the suppressor cap and ensure its proper fitment.

### **Caution**

Always use only recommended make and type of spark plug. **Replace spark plug every 12000 km.**

Don't remove the spark plug when the engine is hot. Cover the spark plug hole with a clean cloth when the plug is removed, to prevent dust / water entry.

It is advisable to tight the new spark plug by hand till the end and then loose. Again re-tight the spark plug by 1/8 of rotation after sealing by using only the hand tool.

Since the hook type spark plug is used, it is not advised to adjust the plug electrodes as it may damage the electrodes.

## ENGINE OIL LEVEL

Check the engine oil level periodically.

1. Place the vehicle on centre stand on a flat surface. Wipe-off the surroundings of gauge oil level.
2. Remove the gauge and wipe it clean.
3. Fix the gauge back to its mounting hole. Do not thread in.
4. Take out the gauge and check the oil level. The level should be between minimum and maximum level marks of the gauge (shown in the figure).
5. If the oil is less than the minimum level, add 'TVS TRU4 SKUUTA oil (SAE 10W30 API-SL, JASO MB)' upto the maximum level mark.



6. Wipe out the oil traces with a clean cloth to prevent dust accumulation.
7. Assemble back the gauge oil level.

### TRANSMISSION OIL - LEVEL

Check the transmission oil level periodically. To check the transmission oil level follow the procedure given below:

1. Place the vehicle on centre stand on a flat surface.
2. Wipe-off the surroundings of oil level screw.
3. Remove the transmission oil level screw along with a gasket from the rear end of crankcase L.

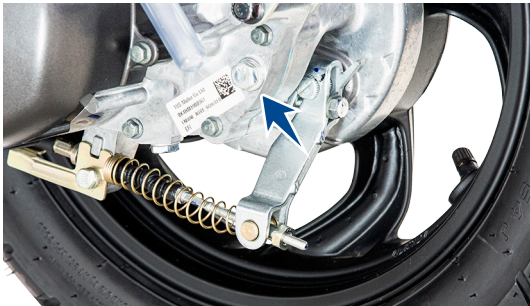

4. Check for the flow of oil from oil level hole. If the level is less (if there is no oil flow), top-up with 'TVS TRU4 SKUUTA oil (SAE 10W30 API-SL, JASO MB)' till the oil just starts to flow out from the oil level hole.
5. Wipe out the oil traces with a clean cloth to prevent dust accumulation.
6. Inspect the condition washer while reassembling the oil level screw. Replace if required.

### **Caution**

*If the vehicle is driven with less engine oil and transmission oil, the engine components will be severely damaged.*

*Check the oil level between the services to avoid costly damage. Do not fill excess oil it may cause oil leak. Always use TVS TRU4 SKUUTA oil (SAE 10W30 API-SL, JASO MB) only.*



## BRAKES

### Front brake - Disc brake type

1. You can observe a master cylinder (1) at the right side of the handle bar under the head lamp housing.
2. A caliper assembly (2) fitted to the fork leg L, a disc (3) on the front wheel and a high pressure hose (4) connecting the master cylinder and the caliper assembly.



3. Check the master cylinder brake fluid level through the view piece glass (A).
4. The brake fluid level always should be above the 'MIN' mark (B) provided on the view piece glass of the master cylinder when the cylinder is parallel to ground.

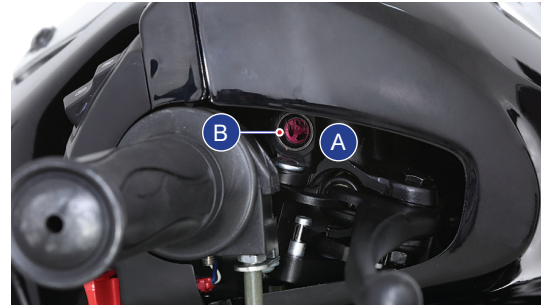

### Warning

Since the vehicle is fitted disc brake SBS system, if there is any abnormality in brake performance, contact TVS Motor Company Authorised Main Dealer / Authorised Dealer.

- If the brake fluid level is below the 'MIN' mark or while applying brake if you feel the brake is more spongy or ineffective due to air entry and if any rattling play is observed in both the brake levers, contact TVS Motor Company Authorised Main Dealer / Authorised Dealer for topping-up the brake fluid, air bleeding and other brake related inspections.

### Brake pad wear indicator

Check for the wear of brake pads visually. If the brake pads wear is found beyond the wear indicator groove as shown in the figure, replace the brake pads as a set with a new one.

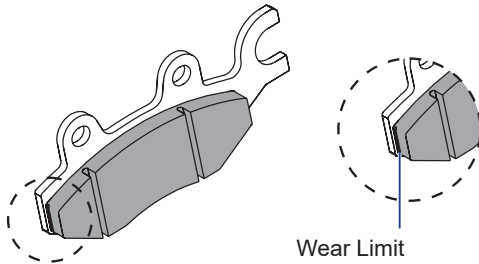

### Front brake - Drum brake type

- Measure the free play of the front brake lever at the lever end as shown in the figure.
- The free play of the brake lever before the engagement of brake should be between 15 ~ 20 mm.
- Turn the adjuster nut at the bottom side (1) in the slot marked as '1' in clockwise direction for reducing the free play or in anti-clockwise direction for increasing the free play.

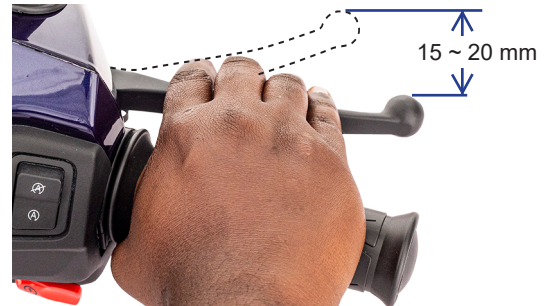



4. After obtaining the necessary free play, inspect for the clearance between the bullet (3) and slot end (4) marked as 'S' as shown in the figure.

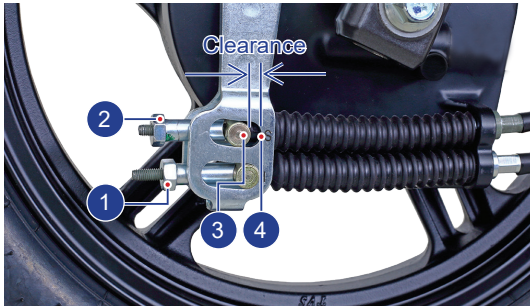

5. If any clearance is found, turn the adjuster nut (2) at the top side in the slot marked as 'S' in clockwise direction until there is no clearance between the bullet top (3) and the slot top (4).

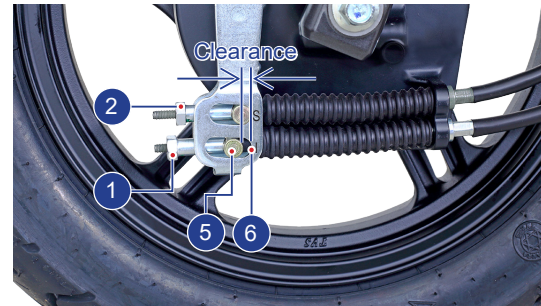

6. After adjusting the adjuster nut top, If any clearance is observed in between the bullet bottom (5) and the slot bottom (6) marked as 'I' as shown, then turn the adjuster nut (2) in anti-clockwise until there is no clearance.
7. Once again check and confirm the brake play at the lever end.

## **Warning**

**Since the vehicle is fitted with Synchronised Braking Technology (SBT) adjust the brakes with additional care. If not it may result in brakes not working properly.** Please contact TVS Motor Company Authorised Main Dealer / Authorised Dealer for further assistance.

### **Front brake shoe wear indicator**

When the brake is applied, wear limit index mark (1) on the front brake cam should be within the wear limit indicator (2) on the front brake panel.

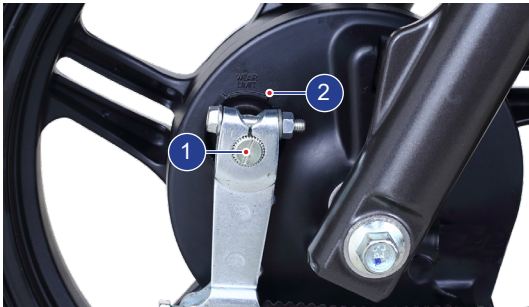

Incase the wear limit index mark (1) is going beyond wear limit indicator (2), index the lever to next slot with the help of the Dealer to extend the shoe life.

## **Caution**

Replace the brake shoes as a set, if the wear limit indicator shows beyond the wear limit even after indexing the lever.

## Rear brake

1. Measure the free play of the rear brake lever at the lever end as shown in the figure.
2. Free play of the brake lever before the engagement of brake should be between 10 ~ 15 mm.

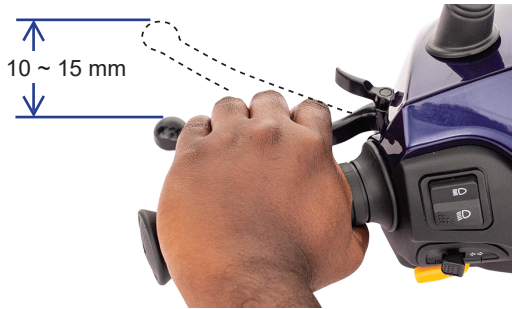

### Note

**Please remember that the rear brake lever free play adjustment to be done only after adjusting the front brake lever play (in drum brake model).**

3. If the measured distance is more than the limit, adjust the nut provided at the rear wheel end to obtain the correct play.
4. Turn the adjuster nut in clockwise direction for reducing free play or in anti-clockwise direction for increasing the free play.



### Warning

*Check the front brake and the rear brake play periodically and adjust if required. However the brake play needs to be adjusted more frequently depending upon the usage.*

## Brake shoe wear indicator

When the brake is applied, the wear limit indication pointer (1) on the rear brake cam lever should be within the wear limit indicator (2) on the crankcase LH.

In case the wear limit indication pointer (1) is going beyond wear limit indicator (2), index the lever to next slot with the help of Dealers to extend shoe life.

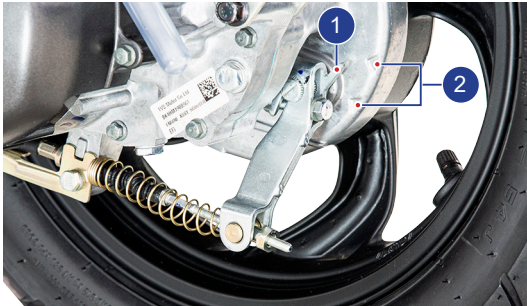

### **Caution**

*Replace the brake shoes as a set, if the wear limit indicator shows beyond the wear limit even after indexing the lever.*

## REAR SHOCK ABSORBERS

TVS Jupiter 125 is provided with 3 step adjustable rear shock absorbers to meet different road and load. There are 3 notches for adjusting spring load.

If the spring is adjusted to the minimum notch, then the shock absorber will be softer which is good for light loads. If the spring is adjusted to maximum notch, then it will be stiffer which is good for heavy loads.

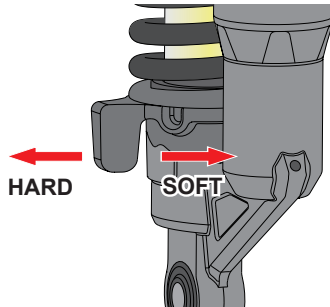

Adjust the spring pre-load by shifting the adjuster to the required notch according to the different load conditions. The more you compress the spring, the suspension becomes more stiff.



## TYRES

### Tyre pressure

Check the tyre pressure atleast once in a week if not more frequently. Insufficient air pressure in the tyres not only hasten the tyre wear, but also seriously affects the stability of the vehicle.

Under inflated tyres make smooth cornering difficult and over inflated tyres decreases the tyre contact with the ground which can lead to skidding and loss of control.

Be sure that the tyre pressure is within the specified limit at all times.

Tyre pressure in cold condition:

	Solo	Dual
Front	1.68 kg/cm <sup>2</sup> (24 PSI)	1.68 kg/cm <sup>2</sup> (24 PSI)
Rear	2.25 kg/cm <sup>2</sup> (32 PSI)	2.53 kg/cm <sup>2</sup> (36 PSI)

### Tyre tread condition

Operating the vehicle with excessively worn tyres will decrease riding stability and can lead to loss of control. It is recommended to replace the tyre when the tyre wears off to the tyre wear indicator level (indicated by TWI (A) on the tyre).



### Tyre rotation direction

While reassembling the tyres, after removing from the wheel rim, ensure that the arrow mark is facing the direction of wheel rotation while fixing the tyre on the wheel rim.

### Tyre puncture

Your scooter is fitted with a tubeless tyre on both front and rear wheel. Incase of any puncture / tyre damage, it is advised to visit the nearest tyre manufacturer Dealer or the tyre repair shops who knows the repairing method of tubeless tyre.

It is not necessary to remove the tyre from wheel rim always to attend a puncture.



Even though, if there is need of tyre removal, it is strongly recommended to use a tyre removal / fitment machine.

If at all, tyre levers needs to be used, the levers should be free from sharp edges. Care should be taken not to damage the tyres and rims.

### **Warning**

*The tyre inflation pressure in cold condition and the tyre tread condition are extremely important for the performance and safety of the rider. Check the tyres frequently for inflation pressure as well as the wear pattern on it.*

*Use of a tyre other than the standard may cause instability.*

### **Caution**

*The side walls of the tubeless tyre which in contact with the wheel rim are only seals the air inside the wheel assembly. Hence care should be taken not to damage the side walls of the tyres during removal / reassembly.*

## Tyre maintenance tips

### Inflation pressure check - Condition



Within  
1 km



Within  
5 km

### Note

*If vehicle is in hold condition for long time*

- Need movement of vehicle to avoid particular spot of tyre not to touch the ground for more than week time.
- Inflation pressure should check on cold condition maximum travel time should not exceed more than 1 km.
- Weekly basis inflation pressure check helps to improve 10% of tread life & fuel efficiency.

## FRONT WHEEL REMOVAL AND REASSEMBLY

1. Remove the axle nut (1) along with a washer.
2. Pull out the axle (2) and take out the spacers from both sides of the wheel (incase of disc brake) or take out a spacer from the right side of the wheel (incase of drum brake).
3. Place a support below the foot board to prevent the vehicle from falling and lift the vehicle up.
4. Dislocate the wheel disc from caliper assembly and take out the wheel.
5. Reverse the procedure for reassembling. Ensure the proper seating of wheel disc in the caliper assembly during reassembly. Also ensure to fix the right spacer at right location.



## REAR WHEEL REMOVAL AND REASSEMBLY

1. Place the vehicle on the centre stand.
2. Hold the rear brake firmly and remove the wheel mounting nut (A) along with a washer.
3. Slightly tilt the vehicle and take out the wheel from the rear axle.
4. Reassemble the wheel in the reverse order of removal.



### **Warning**

*Always make sure, whenever the wheel is removed, the axle nuts are tightened properly to the specified torque.*

## STORAGE PROCEDURES

For storage of your scooter for longer period of over a month and above, we recommend to carry out the following steps:

1. Clean the vehicle thoroughly. Park the vehicle on centre stand.
2. Warm up the engine and drain engine oil and transmission oil. Store the oil, if new, in a dust free container.
3. Empty the fuel tank.
4. Remove the spark plug and feed in several drops of engine oil through spark plug hole. Crank the engine few times and reinstall the spark plug.
5. Remove the battery, store it away from direct sunlight and freezing temperatures.
6. Place a suitable support at the bottom of the foot board so that both the tyres are off the ground. This will ensure better tyre life.
7. Cover up the vehicle completely with a clean tarpaulin or any other suitable cover.
8. Store the vehicle inside a garage or similar area to avoid damage due to dust and rain. Make sure that the storage area is well ventilated and free from any source of flame or spark.



### Caution

*Do not park the vehicle on a slope or soft ground or else it may fall down. The exhaust system becomes hot after a run. Park the vehicle in a place where pedestrians or children are not likely to touch the vehicle.*

*During storage, the battery must be recharged at recommended charger if stored more than a month.*

## TAKING THE VEHICLE OUT OF STORAGE FOR REGULAR USE

1. Take the vehicle out of garage and clean it thoroughly.
2. Remount the battery after bench charging if required.
3. Fill the engine oil (TVS TRU4 SKUUTA - SAE 10W30 API-SL, JASO MB oil) and check the oil level using gauge oil level.
4. Fill the transmission oil (TVSTRU4 SKUUTA - SAE 10W30 API-SL, JASO MB oil) and check the oil level at the oil level screw.
5. Lubricate the parts as instructed in the periodic maintenance schedule.
6. Fill up fresh petrol in the fuel tank.
7. Check and inflate the tyres to the specified tyre pressure.
8. Check and correct the points mentioned in page No. 44.
9. Turn the ignition switch to 'ON' position. Retract the side stand and start the engine. Wait for few seconds and ride out.



### Caution

*Avoid using alkaline solution like detergent soaps for washing. This may damage head lamp and other lamp assemblies.*

## RECOMMENDED TIPS WHEN TAKING A LONG TRIP OF MORE THAN 500 KM:

- A) Please keep the following items for use in case of emergency:
1. Tool kit complete.
  2. Recommended spark plug one number.
  3. Turn signal lamp bulb one number.
  4. Throttle, front# and rear brake cable each one.
  5. First aid kit.
- B) Precautions to be taken for the journey:
1. Ensure that the engine oil and transmission oil are up to the level.
  2. Adequate fuel in the fuel tank.
- C) Check your scooter for the following:
1. Tightness of all bolts and nuts with correct torque value.
  2. Fitness of tyres / tyre pressure / tread depth.
  3. All bulbs, indicators and horn functioning.
  4. Smooth functioning of all cables and their free play.
  5. Smoothness of steering operation.
  6. Front / rear brake function and rear brake lamp working.

7. Front fork for any abnormality.
8. Spark plug gap and condition of spark plug.
9. Air filter element cleanliness.
10. MIL & ISG lamps are not glowing.
11. Lubrication of all items mentioned in the periodic maintenance schedule.
12. Any other job as necessary.
13. Have your vehicle checked at any TVS Motor Company Authorised Main Dealer or Authorised Dealer.



### Caution

*Long journey are to be taken only after the running-in period of 1000 km.*

*# Applicable only for Drum Brake version*

**TVS Motor Company Limited ('the Company') give this warranty with respect to the TVS Jupiter 125 manufactured by the Company.**

While the Company has taken every care to maintain quality in the manufacture of the TVS Jupiter 125, the above said warranty is subject to other terms of warranty:

During 5 Years from the date of purchase or during the first 50,000 km of run for the vehicle in the hands of original retail purchaser, whichever is earlier, the parts of the vehicle covered under warranty which prove to the satisfaction of the Company to have a manufacturing defect will be repaired or replaced free of cost.

The Company's obligation under this warranty is limited to repairing or replacing, free of cost, those parts of the vehicle which upon examination by the Company may prove to the Company's satisfaction to have a manufacturing defect, and in such cases the Company's decision either to repair or replace the affected parts will be final. In the event of replacement of parts, the Company also reserves the right to use parts of the same brand as the affected parts or any other brand which is used by the Company in the course of manufacture. All parts replaced under this warranty will become the property of the Company and must be returned to the company.

**Limitations of Warranty:**

This warranty shall not apply to following condition:

1. Any natural wear and tear, including without limitation, aging.
2. Warranty claims on proprietary items such as tyres, tubes and batteries etc., should be preferred by the user directly on the respective manufacturer, as per their warranty terms and the Company shall not be liable in any manner in respect to the same.
  - Battery warranty for "MF type (Maintenance Free)" is applicable for a period of 21 months from the date of charging or 18 months from the date of sale or 20,000 kms, whichever is earlier.
  - Battery warranty for "Lead Acid type" is applicable for a period of 15 months from date of charging or 12 months from date of sale or 10000 kms whichever is earlier.
3. Parts repaired or replaced under this warranty are warranted only throughout the remainder of the original warranty period.

4. The Company is not liable for any delay in servicing due to reasons beyond the control of the Company or any of its Authorised Main Dealers / Authorised Dealers.
5. In any event, the Company is not liable for indirect, remote, incidental or consequential damages.
6. The Company may make any modification or improvement to vehicles in future production at any time without prior notice and without any obligation to install the same on vehicles previously dispatched for sale.
7. Any claim under this warranty will lie only when the customer:
  - takes his vehicle to an Authorised Main Dealer / Authorised Dealer of the Company and reports the problem he / she felt in the vehicle to enable the Authorised Main Dealer / Authorised Dealer to inspect the same and assess the cause for the reported problems.
  - produces to such Authorised Main Dealer / Authorised Dealer the owner's manual for the concerned vehicle for verification of relevant details.
8. This is the only warranty given by the Company for the TVS Jupiter 125. No employee, Dealer or other person is authorised to extend or enlarge this warranty.

 **Warning**

*Modifications to this vehicle not approved by the TVS Motor Company may cause loss of performance and render it unsafe for use and disqualifies for warranty coverage also.*

**Following Toll Free numbers can be contacted for battery related queries if any.**

*Incase of EXIDE battery, call :- 1800 103 5454      Incase of AMCO battery, call :- 1800 425 0096*

*Incase of TATA GREEN battery, call :- 1800 419 8888      Incase of AMARON battery, call :- 1800 425 5858*

**Following Toll Free numbers can be contacted for Tyre related queries if any.**

*Incase of TVS Srichakra, call :- 04522443300      Incase of JK tyre, call :- 18002581100*

*Incase of Maxxis tyre, call :- 1800 532 2888*



## List of parts not covered under warranty

ITEM	WHAT TO CHECK FOR
Normal Maintenance Operations	Engine tune-up, decarbonizing, fuel system cleaning, oil changes, head light focusing, fastener retightening, ignition timing, clutch and brakes as well as other normal adjustments.
Wear and Tear Items	Chain, sprockets, clutch and brake linings, fasteners, shims, washers, oil seals, gaskets, 'O' rings and spokes etc.
Electrical	Bulbs, fuse, AHO, DRL etc.
Service Maintenance Parts	Oil filters, spark plug, air filter, oil and brake fluid
Rubber, Rexine and Plastic Items	All hoses, pipes and plastic aesthetics
Proprietary Items	<p>Battery, tyres and tubes (the warranty terms are subject to our agreement with proprietary OEM)</p> <p>(Battery warranty for "MF type (Maintenance Free)" is applicable for a period of 21 months from the date of charging or 18 months from the date of sale or 20,000 kms, whichever is earlier).</p> <p>(Battery warranty for "Lead Acid type" is applicable for a period of 15 months from date of charging or 12 months from date of sale or 10000 kms whichever is earlier).</p>
Others Factors	Parts of the vehicle getting affected due to atmospheric effect / environmental factors (rusting, paint peel off etc.). However, depending on the vehicle usage condition, warranty would be accepted up to 2 years from the date of purchase.
	Parts of the vehicle which have been tampered with, altered, repaired or replaced by persons not authorised by the Company and which in the sole judgement of the Company affect the performance of the vehicle.

## List of parts not covered under warranty

ITEM	WHAT TO CHECK FOR
Others Factors	Parts which are used in conjunction with parts not made or recommended by the Company.
	Parts suffering damage or resultant damage by accident, misuse, negligent treatment, use of bad quality lubricants or impure fuel or by omission to follow the guidance and instructions contained in this owner's manual.
	Vehicles on which engine number or chassis number is deleted, defaced or altered.
	Vehicles on which any warranty service including scheduled paid service is not availed when it falls due (at TVS Motor Company Authorised Main Dealer / Authorised Dealer).
	Vehicles sold or transferred by original retail purchaser.
	Vehicles used for racing or any competition or used otherwise than for ordinary personal transportation.
	Vehicles attached with side cars etc. Vehicles which have been taken out of India. Vehicles affected by natural calamities like flood, earthquake, tsunami, storm etc.,.
If the vehicle has been used for commercial purpose like taxi or used for rental or hiring or any other purpose other than regular personal transportation.	

## SERVICE INFORMATION

There are nine services for TVS Jupiter 125 during warranty period. Of these, first three services are free services for which labour charges are free. In addition to these three free services, we have a scheme of six pay services. For keeping the maintenance track of your vehicle, free and pay service record sheets are attached in the Service Handbook given to you during the time of your vehicle purchase. Please have the relevant record sheet filled by the Dealer who is carrying out the maintenance service.

For availing any of the nine warranty services, please take your vehicle and your Service Handbook to any of our Authorised Main Dealers or any of our Authorised Dealer. After effecting the service the Authorised Main Dealer or the Authorised Dealer will affix their stamp on the last column of free or pay service record sheet of Service Handbook for your record and reference. An OTP would be sent to customer's registered mobile number. The same to be shared with the servicing Dealer on or before vehicle delivery.

Periodic maintenance always helps good performance of an automobile and our services are planned to keep your TVS Jupiter 125 performing good. **Please note that carrying out the service for your vehicle at scheduled intervals at any of the TVS Motor Company Authorised Main Dealer / Authorised Dealer is necessary for availing of warranty.** And please also remember that, after the services are over, periodic servicing of your vehicle at appropriate intervals, depending upon its extent of use, will keep your vehicle at its best level of performance.

In case you need any clarification or assistance, please feel free to write to us mentioning the frame number, engine number and date of purchase of your vehicle also the name and place of the Authorised Main Dealer / Authorised Dealer from whom you bought the vehicle and getting it serviced.

**Service Department**  
**TVS MOTOR COMPANY LIMITED**  
**P.O. Box No. 4, Harita, Hosur - 635 109,**  
**TAMILNADU, INDIA.**  
**Toll free no:- 1800-258-7111**

### Planned Service Schedule (kms or month whichever of the two occurs early)\*

Sl.No.	Service	Type	Kms	Months
1	1st Service	Free	500 ~ 750	30 ~ 60 days
2	2nd Service	Free	5500 ~ 6000	6
3	3rd Service	Free	11500 ~ 12000	12
4	4th Service	Pay	17500 ~ 18000	18
5	5th Service	Pay	23500 ~ 24000	24
6	6th Service	Pay	29500 ~ 30000	30
7	7th Service	Pay	35500 ~ 36000	36
8	8th Service	Pay	41500 ~ 42000	42
9	9th Service	Pay	47500 ~ 48000	48

#### Note

Free service enables the customer to avail the service at free of labour charges. Charges for the pay service should be borne by the customer. Cost of engine oil, periodic maintenance parts, filter, brake fluids, all types of greases, petroleum jelly, distilled water, chain cleaner, lubricants, coolants, cleaning cloths for both free and paid services are chargeable to the customer.

\* Please remember that, after the above schedule, periodic servicing of your vehicle at appropriate intervals, depending upon its extent of use, will keep your vehicle at its best level of performance.

DESCRIPTION	TVS Jupiter 125 (Alloy Wheel - Disc / Drum Type)
<b>MANUFACTURER</b>	TVS Motor Company Limited P. B. No. 4, Harita, Hosur - 635 109, India  TVS Motor Company Limited Village Bhatian, Bharatgarh Road, Teh Nalagarh, Dist. Solan. Himachal Pradesh - 174 101, India
<b>ENGINE</b>	
Type	Single cylinder, 4 stroke, fuel injection, air cooled, spark ignition engine
Cylinder bore	53.5 mm
Stroke	55.5 mm
Piston displacement	124.76 cc
Compression ratio	10.3 ± 0.3 : 1
Air filter	Dry paper filter element
Oil filter	Wire mesh
Lubrication system	Forced wet sump
Maximum power in kW	6.0 kW @ 6500 rpm
Maximum torque in Nm	10.5 Nm @ 4500 rpm
Maximum speed	84 km/h
Engine idling rpm	1450 ± 100 rpm (under warm condition)
Starting system	Electric starter
Emission norms	BS VI

DESCRIPTION	TVS Jupiter 125 (Alloy Wheel - Disc / Drum Type)
<b>TRANSMISSION</b>	
Clutch	Dry - Centrifugal clutch
Primary transmission	CVT (Continuously Variable Transmission)
Primary reduction	2.58 to 0.8
Secondary reduction	9.08
<b>CHASSIS</b>	
Overall length	1852 mm
Overall width	681 mm
Overall height	1168 mm
Seat length	860 mm
Ground clearance (unladen)	160 mm
Wheel base	1275 mm
Kerb weight (with toolkit and 90% of fuel)	108 kg (front alloy wheel disc & rear alloy wheel drum type) 107 kg (front & rear alloy wheel drum type)
Pay load	130 kg
Maximum laden weight	238 kg (front alloy wheel disc & rear alloy wheel drum type) 237 kg (front & rear alloy wheel drum type)
Steering angle	90°
Caster angle	25°
Frame	High rigidity underbone type
Front suspension	Telescopic hydraulic
Rear suspension	Toggle link, gas filled hydraulic damper
Trail length	93 mm

DESCRIPTION	TVS Jupiter 125 (Alloy Wheel - Disc / Drum Type)
<b>BRAKES</b>	
Front (Disc)#	220 mm dia (hand operated)
Front (Drum)	130 mm dia (hand operated)
Rear (Drum)	130 mm dia (hand operated)
<b>TYRE</b>	
Front tyre	90/90 - 12 54J (tubeless)
Rear tyre	90/90 - 12 54J (tubeless)
Front tyre pressure**	1.68 kg/cm <sup>2</sup> (24 PSI)
Rear tyre pressure - Solo**	2.25 kg/cm <sup>2</sup> (32 PSI)
Rear tyre pressure - Dual**	2.53 kg/cm <sup>2</sup> (36 PSI)
<b>ELECTRICAL</b>	
Ignition system	ECU controlled ignition
Spark plug	BOSCH UR5KCU / CHAMPION RG8MC5
Spark plug gap	1.0 ~ 1.1 mm
Battery type	12V, 4Ah MF battery
Generator (flywheel magneto)	12V, 130W
Head lamp	9V, 9.5W High beam LED / 6V, 5W Low beam LED
Tail / brake lamp	12V, 10/5W

# Applicable only for Disc Brake version

\*\* In cold condition

DESCRIPTION	TVS Jupiter 125 (Alloy Wheel - Disc / Drum Type)
<b>ELECTRICAL</b>	
Turn signal lamps bulb	12V, 10W x 4
Number plate lamp bulb	12V, 3W x 1
Turn signal indicator lamp bulb	12V, LED
Instrument cluster	LCD / LED indicators
High beam indicator lamp	12V, LED
Low fuel warning lamp	12V, LED
Economy and power mode indicator lamp	12V, LED
Malfunction indicator lamp	12V, LED
ISG malfunction indicator lamp	12V, LED
Horn	12V, DC
Fuse	Blade type - 12V, 15A x 1 / Mini fuse 12V, 15A x 1 & 12V, 10A x 1

 **Caution**

*Using the bulb other than the specified rating can result in overloading of the electrical system or premature failure of the bulb.*



DESCRIPTION	TVS Jupiter 125 (Alloy Wheel - Disc / Drum Type)
<b>CAPACITIES</b>	
Fuel tank capacity**	5.1 l
Fuel	BS VI petrol with minimum RON 91 (containing upto 20% of ethanol by volume)
Engine / transmission oil grade	TVSTRU4 SKUUTA oil (SAE 10W30 API-SL, JASO MB)
Engine oil capacity	700 ml
Transmission oil capacity	120 ml
Front fork oil grade	Gabriel Premium front fork oil
Front fork oil capacity	92 ± 1 ml per leg
Disc brake fluid#	TVS Girling DOT 3 / DOT 4

 **Note**

*Specifications are subject to change without notice.*

\*\* The fuel tank is not a measuring instrument and the capacity of the fuel tank may vary from the indicated capacity

# Applicable only for Disc Brake version

Dear Customer,

It is mandatory under the Motor Vehicles Act to insure all motor vehicles. No motor vehicle can be used in a public place without a valid policy of insurance issued by an authorised insurer. Driving a motor vehicle without any such insurance is an offense under Motor Vehicles Act.

To assist our Customers on their insurance requirements such as the prompt issue and renewal of policies as well as expeditious settlement of claims if any, our preferred insurers are:





ALWAYS USE TVS-M GENUINE PARTS



TVS MOTOR COMPANY LIMITED. P.B. No.4, Harita, Hosur, 635109, Tamil Nadu, India.  
Telephone: +91 (4344) 276780. Fax: +91 (4344) 276878 / 277311 [www.tvsmotor.com](http://www.tvsmotor.com)