

TVS 

TVS **NTORQ 125**  
**RACE XPI**  
PLAY SMART

**OWNER'S MANUAL**



SCAN FOR 24X7  
ROADSIDE ASSISTANCE NOW

**WE GO THE DISTANCE  
WHEN IT COMES  
TO YOUR ASSISTANCE.**

MAKE YOUR RIDES HASSLE-FREE AND STRESS-FREE  
WITH SERVICE BEYOND JUST ASSISTANCE.

Sign up for our 24X7 Roadside Assistance and enjoy  
quick and efficient service anytime, anywhere.





**Drive In.**

**Drive Out.**



**Say bye-bye to waiting time  
for servicing your bike.**

**Get your vehicle serviced in 1 hour at no additional cost. Contact your nearest Dealership for details. †**

† Facility available at selected Dealerships only. Terms and conditions apply





# Busy Life? Easy Servicing!

Now, service your bike anywhere, anytime.

- ★ Service the vehicle at your door step.
- ★ Available for regular maintenance or breakdown service only.
- ★ Offered at nominal convenience charges.

Contact your nearest Dealership for details.<sup>†</sup>

<sup>†</sup>Facility available at selected Dealerships only. Terms and conditions apply





# Busy Life? Easy Servicing!

Now, service your bike anywhere, anytime.

- ★ Service the vehicle at your door step.
- ★ Available for regular maintenance or breakdown service only.
- ★ Offered at nominal convenience charges.

**Contact your nearest Dealership for details.<sup>†</sup>**

<sup>†</sup>Facility available at selected Dealerships only. Terms and conditions apply

EXPRESS SERVICE	I
EXPERT ON WHEELS	II
PICKUP AND DROP	III
CONTENTS	IV
CONTACT(S) FOR SUPPORT	1
UNIQUE FEATURES OF TVS NTORQ 125 RACE XP	5
FOREWORD	10
NOTICE	11
SAFETY INFORMATION	12
RUNNING-IN INFORMATION	13
SAFE RIDING TIPS	14
KNOW YOUR TVS NTORQ 125 RACE XP	18
RIDING YOUR TVS NTORQ 125 RACE XP	77
MAINTENANCE	81
WARRANTY AND SERVICES	103
TECHNICAL SPECIFICATIONS	110
GENERAL INFORMATION	113



**Incase you need any Clarification please contact**

**TVS Motor Company Authorised Main Dealer / Authorised Dealer**

**Or**

**TVS Motor Company's Area Offices (flip over for addresses)**

**Or**

**Toll Free Number : 1800-258-7111**

**Email : [customercare@tvsmotor.com](mailto:customercare@tvsmotor.com)**

**Disclaimer :** TVS Motor Company or any of its officials / Authorized Main dealer / Authorized Dealer do not ask customers for bank / card / wallet details / authentication. In case you face any such claim, please report to the relevant local authorities immediately.

## CONTACT AT OUR AREA OFFICES

### TAMILNADU-1, 3 & 4

#### 1. TVS Motor Company Limited

V Floor, Gee Gee Universal,  
No. 2, MC Nichols Road,  
Chetpet, Chennai - 600 031.  
Phone : 044-28361651/28361654  
Email : AO.Chennai@tvs motor.com  
AO.Madurai@tvs motor.com

### TAMILNADU-2

#### 2. TVS Motor Company Limited

No. 10, 2nd floor,  
Shree Shanmugapriya Towers,  
Kannuswamy Street,  
Behind Hotel Annapoorna,  
R S Puram, Coimbatore - 641 002.  
Phone : 0422-4350060/2541035  
Email : AO.Coimbatore@tvs motor.com

### KERALA

#### 3. TVS Motor Company Limited

Ambady Towers, Second Floor,  
Door No. 27/631, A6,  
Edappally-Pookkattupady Road,  
Edappally PO., Cochin - 682 024.  
Phone : 0484-2544578/2556938  
Email : AO.Cochin@tvs motor.com

### KARNATAKA-1, 2 & GOA

#### 4. TVS Motor Company Limited

No. 600, Anand Surya, 2nd Floor,  
15th Cross, 6th Phase, JP Nagar,  
Opp. BMTC Bus Stop,  
Bangalore - 560 078.  
Phone : 080-26653433  
Email : AO.Bangalore@tvs motor.com

### ANDHRAPRADESH & TELANGANA

#### 5. TVS Motor Company Limited

Rukumani Towers, First Floor,  
No. 3-11-30, Plot No. 11,  
Paigha Colony, Behind Anand Theater,  
Secunderabad - 500 003.  
Phone : 040-27840590/27844419  
Email : AO.Hyderabad@tvs motor.com  
AO.Vijayawada@tvs motor.com

### MAHARASHTRA-1 & 2

#### 6. TVS Motor Company Limited

No. 401, 4th Floor, The Chambers,  
Plot No. 4/12/3, Near Ganapati Chowk,  
Viman Nagar, Pune - 411 014.  
Phone : 020-26632112/26632110  
Email : Service.pune@tvs motor.com

### MAHARASHTRA-3 & CHATTISGARH

#### 7. TVS Motor Company Limited

No. 502B, 6th Floor, B Wing,  
Shriram Shyam Towers,  
Near LIC Square, Sardar,  
Nagpur - 440 001.  
Phone : 0712-2569932  
Email : Service.Nagpur@tvs motor.com  
AO.Raipur@tvs motor.com

### GUJARAT

#### 8. TVS Motor Company Limited

1208-1213, Shivalik Satyamev,  
Below Bopal Over Bridge,  
Ambli-SP Ring Road Junction, Bopal,  
Ahmedabad- 380058.  
Phone : 079-65443748  
Email : AO.Ahmedabad@tvs motor.com



**MADHYA PRADESH-1 & 2****9. TVS Motor Company Limited**

No. 211-212, 2nd Floor,  
Chinar Incube Business Centre,  
Chinar Fortune City,  
Near Brindhavan Dhaba,  
Hosangabad Road,  
Bhopal - 462 026.  
Phone : 0755-2499406/2499306  
Email : AO.Bhopal@tvsmotor.com  
AO.Indore@tvsmotor.com

**RAJASTHAN-1 & 2****10. TVS Motor Company Limited**

Plot No. 17-18,  
2nd Floor of National Motors Building,  
Jhotwara Industrial Area,  
Jaipur - 302 012.  
Phone : 0141-5150901/5150902  
Email : AO.Jaipur@tvsmotor.com  
AO.Udaipur@tvsmotor.com

**DELHI & HARYANA****11. TVS Motor Company Limited**

D-3 & D-4, 2nd Floor,  
Sector - 10, Noida,  
Uttar Pradesh - 201 301.  
Phone : 011-29834640/29834773  
Email : AO.Delhi@tvsmotor.com

**PUNJAB & CHANDIGARH****12. TVS Motor Company Limited**

4th Floor, Royal Business Park,  
Chandigarh Ambala Highway,  
Zirkapur - 140 603.  
Phone : 01762-464777/465777  
Email : AO.Chandigarh@tvsmotor.com

**UTTAR PRADESH WEST****13. TVS Motor Company Limited**

D-3 & D-4, 2nd Floor,  
Sector - 10, Noida,  
Uttar Pradesh - 201 301.  
Phone : 011-29834640/29834773  
Email : AO.Delhi@tvsmotor.com

**UTTAR PRADESH CENTRAL & EAST****14. TVS Motor Company Limited**

1st Floor, Cyber Tower, TC-34/V-2,  
Vibhuti Khand, Gomti Nagar,  
Lucknow - 226 010.  
Phone : 0522-4918300/4918301  
Email : AO.Lucknow@tvsmotor.com

**WEST BENGAL****15. TVS Motor Company Limited**

Ground Floor & First Floor,  
133 A. S. P. Mukherjee Road,  
Opp. Tollygunge Police Station,  
Kolkatta - 700 026.  
Phone : 033-24617096/24617092  
Email : AO.Kolkatta@tvsmotor.com

**BIHAR****16. TVS Motor Company Limited**

N-Plaza, Jamal Road,  
P.S. Kotwali,  
Patna - 800 001.  
Phone : 0612-2200068/2200069  
Email : AO.BNJ@tvsmotor.com

## **ORISSA & JHARKHAND**

### **17. TVS Motor Company Limited**

No. 303, 3rd Floor,  
Creative Plaza, Rasulgarh,  
Bhubaneswar - 751 010.  
Phone : 0674-2580019  
Email : AO.Bhubaneswar@tvsmotor.com

## **NORTH EAST STATES**

### **18. TVS Motor Company Limited**

147, Udayan, Ganesh Guri,  
Near Hotel D Courtyard,  
R G B. Road, Guwahati - 781 005.  
Phone : 0361-2202030/2202031  
Email : AO.Guwahati@tvsmotor.com

### 3-VALVE 125 CVTi - Revv ENGINE

Your scooter is India's 1st 125cc scooter having engine more than 10 ps power. The additional intake valve in your scooter helps in faster filling of petrol-air mixture and faster & better combustion.



### FULLY DIGITAL CONNECTED INSTRUMENT CLUSTER WITH ON-BOARD DIAGNOSTIC

Your scooter is fitted with 'Fully Digital Connected Instrument Cluster'. This first-in class cluster housed perfectly in the headlamp housing of your scooter. An Engine Malfunction Indication lamp is added to glow whenever any engine related fault is present in vehicle.



### RIDE MODES

You can change the mode of the vehicle on the fly. Street and Race are two modes of your scooter. For city ride, try using Street mode and for a powerful ride, use Race mode.

### SMARTCONNECT-BLUETOOTH CONNECTIVITY (First Time in Scooters)

The connected instrument cluster of your scooter has a inbuilt Bluetooth® connectivity through which you can connect your Android™ smart phone / iPhone® to access the features like caller ID, SMS and missed call notification, navigation in the cluster and voice assist, ride stats share and incase of Andorid smart phone the last parked location of the vehicle.

### VOICE ASSIST

Another 1st in market feature - TVS NTORQ 125 Race XP is now provided with voice assist. You can use your voice to control various functions like Speedometer brightness, vehicle mode etc. You can use your voice through a connected audio device like a Bluetooth® headphone and control vehicle functions like changing modes or starting navigation instructions to a particular location. You can also set location for navigation, ask for number of missed calls or current location etc. over voice.

### ENGINE KILL SWITCH

'Engine Kill Switch' is an another unique feature of your scooter which allows you to shut the engine without switching OFF the ignition.



### ECONOMETER®

Your scooter's connected instrument cluster has an 'ECONOMETER®' which indicates whether you are riding in Economy Mode or Power Mode. This is an unique feature of your scooter which guides you to ride your scooter fuel efficiently.



### PASS-BY SWITCH

'Pass-by Switch' allows you to easily switch between high and low beam of head lamp with easy press and auto release. It is helpful especially while overtaking.

The same pass-by switch is used to operate head lamp low / high beam continuous glowing.



### LED HEAD LAMP CUM POSITION LAMP WITH ALL TIME HEAD LAMP ON (AHO)

TVS NTORQ 125 Race XP Race Edition comes with premium LED headlamp cum position lamp. Efficient and bright head lamp gives NTORQ a totally upgraded Look and style with better visibility for night rides.



### EXTERNAL FUEL FILL

This is an exclusive facility which allows you to fill petrol without even getting out of your seat.



### LOW FUEL INDICATOR

'Low Fuel Indicator' is yet another unique feature of your scooter which indicates you to refill the fuel when the fuel in the tank goes below minimum safe level.

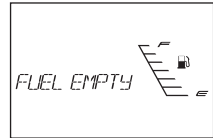

### TEXTURED FLOORBOARD

Your scooter comes with a stylish textured floor board.

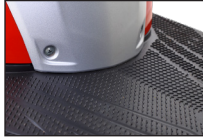

### PETAL DISC BRAKE

Your scooter is fitted with '220 mm Roto - Petal Disc' at the front for effective braking and safe riding even at higher speeds.



### DIAMOND - CUT ALLOY WHEELS

Your scooter has sporty diamond cut alloy wheels.



### CHUNKY TUBELESS TYRES

'Chunky Tubeless Tyres' are another important unique feature in your scooter. Tubeless tyres reduces the chances of getting punctured. Even if there is a puncture, sudden leakage of air is avoided, thereby provide better safety and convenience. It is also very easy to repair the punctured tyres.



### LARGER ALLOY WHEELS

'Larger Alloy Wheels' with high mechanical advantage gives progressive braking of your scooter, results in best-in-class 'Shortest Distance' braking. It also provides superior comfort in bad road conditions.



### PATENTED E-Z CENTRE STAND

'E-Z Centre Stand' of your scooter reduces the effort required to place the scooter on stand.



### RETRACTABLE BAG HOOKS

Your scooter has two retractable 'Bag Hooks' to carry light luggage like carry bags weighing upto 3 kg. One hook is located below the handle bar on the rear panel and the other one is located on the cover front below the front end of the seat.



### LED TAIL LAMP CUM-BRAKE LAMP

Your scooter has a 'LED Tail Lamp-Cum-Brake Lamp' for better visibility and stylish looks.



### PARKING BRAKE (Rear Brake Lock)

'Parking Brake' is another safety feature which protects your scooter from falling due to wheel rotation when it is parked with the side stand on a slope.



### HAZARD SWITCH

TVS NATORQ 125 Race XP comes with a hazard switch which can be used whenever it is necessary to park the scooter in a hazardous location due to emergency situation.



### UNDER-SEAT STORAGE (Utility Box)

Your scooter has a 20 litre 'Under-Seat Storage' space to carry your luggage belongings, full face helmet etc.



### SMART PHONE CHARGER AND UTILITY BOX LIGHT

Your scooter has a 'Smart Phone Charger' which enables you to charge your mobile phone even when you are traveling. Use the charger only when the engine running. The 'Utility Box Light' which lights up the utility box whenever the seat is open (it is fitted by default in disc brake variants. For non-disc brake variants it can be fitted as an accessory on chargeable basis).



### HELMET HOOKS

Your scooter has two 'Helmet Hooks' under the seat assembly at the front end of utility box to secure your helmet.

Your helmets can be hung in this hooks when the vehicle's utility box is filled with your things.



### ACCESSORIES FOR YOUR VEHICLE

To enhance the look, convenience and safety, the below listed accessories available for your scooter.

Ask your Dealer to fix this accessory on your scooter but it will be charged additional.

- Front glove box
- Beeper
- Immobilizer (provides a additional safety of your vehicle when it is parked unattended. When the immobilizer is active, the system alerts you with an alarm when your vehicle is approached by an unauthorized persons).

### Welcome to the NTORQian Tribe!!

If you are reading this, you now own a revolutionary riding experience engineered to shatter barriers and designed to thrill.

### TVS NTORQ 125 RACE XP

India's 1st 125cc scooter with more than 10hp power

India's 1st scooter with Dual Ride Modes

India's 1st scooter with Voice Assist and the next-gen SmartXconnect technology

Race-inspired design, to bring out the racer in you

The TVS NTORQ 125 Race XP races ahead of the curve with Xtra Power, to give you the race track experience in your everyday ride.

This manual is your guide to unlocking the complete potential of your TVS NTORQ 125 Race XP.

And of course, we're sure that a true rider like you will get your Race XP regularly serviced, only at TVS Motor Company's Authorised Main Dealer / Authorised Dealer.

Go ahead, you're ready to Rev Up with Race XP

### TVS MOTOR COMPANY LIMITED



Take time to familiarize yourself with your TVS NTORQ 125 Race XP and its performance characteristics. This Owner's Manual contains a host of useful information. Please take the time to read this manual before you ride your new TVS NTORQ 125 Race XP. Get familiarised with the operation of your scooter for maximum safety and pleasure. The better you know your vehicle, the more pleasure you will experience riding your new vehicle. Ensure that anyone else riding your TVS NTORQ 125 Race XP does the same.

All information, illustrations, photographs and specifications contained in this owner's manual are based on the latest product information available at the time of this publication. TVS Motor Company Limited may, however, incorporate modifications or improvements on its vehicles at any time without notice, and therefore, in such events it is possible that the relevant part of the owner's manual does not apply to your vehicle.

Prior permission of TVS Motor Company Limited is required for quoting, copying or reproducing any part of this owner's manual.

### Note

*Accessories shown in the picture may not be part of the standard equipment. Pictures shown in this manual are of TVS NTORQ 125 Race XP disc brake version unless specified.*

***TVS NTORQ 125 Race XP is provided with All time Head lamp ON (AHO). The head lamp glows automatically once the engine is started without activating any other switch.***

***Since your vehicle is fitted with side stand cut-off system ensure to retract the side stand before starting the vehicle.***

Operating this vehicle safely is an important responsibility of the rider. To help you make decisions on safety, we have provided necessary operating procedure and other information in this manual. This information alerts you on potential hazards that could hurt you or others. Since it is not possible to warn you about all the hazards associated with operating or maintaining the vehicle, you must use your own judgement.

You will find important safety information in following form in this manual. These words carry the following connotations:

 **Warning**

*Disregarding this message might result in injury to the rider or deadly accidents.*

 **Caution**

*This message indicates special procedures or precautions to be followed to avoid damage to the vehicle.*

 **Note**

*This message provides further clarification for clear understanding of any particular information.*

The first 1000 km is a crucial part for the life of your scooter. Proper running-in operation during this period helps in ensuring a **maximum life** and **smooth performance** of your scooter.

The reliability and performance of your scooter depends on the special care and restraint exercised during the running-in period. It is especially important that you avoid operating the engine in high speed (RPM), which could expose the engine parts to excessive stress. Maximum recommended speed during the running-in is:

**Maximum 50 kmph speed upto 1000 km** (vary the engine speed for better mating of parts).

**The first free service at 500 ~ 750 km is most important.** During running-in period all the engine components and other parts will have set in. All adjustments to be restored, all fasteners to be tightened. **Engine and transmission oil to be replaced.** Timely performance of the first free service will ensure optimum service life and performance from the engine.



### Caution

*Replacing the engine and transmission oil during first free service is most important for better life of engine. Always use TVS TRU4 SKUUTA oil (SAE10W30 API-SL, JASO MB) for better performance and life.*

## SAFE RIDING RECOMMENDATIONS

Any two wheeler riding requires some precautions to be taken to ensure the safety of the rider, pillion rider and other road users. These precautions are:

### Familiarise yourself with new TVS NTORQ 125 Race XP

Riding skill and your mechanical knowledge forms the foundation of safe riding practices. We suggest you to practice riding TVS NTORQ 125 Race XP in a low-traffic condition until you are thoroughly familiar with your vehicle and its controls. Remember practice makes you perfect.

### Riding apparel

Loose, fancy clothing can be uncomfortable and unsafe when riding a two-wheeler. Choose good quality two wheeler riding apparel.

### Know your limits

Ride within the boundaries of your own skill at all times. Knowing these limits and staying within them will help you avoid accidents.

### Warning

*Two wheeler safety starts with wearing a good quality helmet. One of the most serious injuries that can happen is a head injury. Always wear an ISI approved helmet that should fit your head comfortably and securely. You should also have good quality goggles to protect your eyes and help your vision.*

*To prevent or minimize accident, never consume alcohol or drugs before or during the operation of your vehicle. Even minimal consumption of these will affect the rider's ability to control the vehicle.*



## Posture

Proper vehicle riding starts with proper posture.

1. Keep your elbows relaxed and flexible.
2. Sit and adjust yourself on seat so that arms and shoulders are relaxed.
3. Look widely instead of gazing at one point.

## Warning

*One-hand riding is dangerous. Keep both hands firmly on the handle bar and both feet securely on the floor board. Under no circumstances should both the hands be removed from the handle bar, as it is very dangerous.*

*Avoid use of mobile phones while riding as it could lead to fatal accident.*

*Slow down to a safe speed before negotiating a corner. If this is the first time that you are riding a vehicle of this type, we suggest that you practice on a safe, open area to thoroughly familiarise with the operation of the vehicle.*

## Cornering

When cornering, centrifugal force works in a direction perpendicular to the direction in which the vehicle is moving. Centrifugal force increases in proportion with speed and the radius of the corner.

During cornering, reduce speed so as to lessen the effects of centrifugal force. By all means, avoid abrupt application of brake or sudden steering.

## Braking

For safe riding, it is very important to master the braking techniques.

1. Close / release the throttle.
2. Hold the vehicle upright as you apply the brake.
3. Progressive application of brakes is safer.
4. **Apply both the brakes. 'SBT' provides additional braking even when 'Only Rear brake' is applied, But applying 'Both the brakes' helps you to use the full potential of the brakes.**
5. Riding down hills, while cornering and wet roads, close throttle and come to a slower speed to avoid the loss of control over the vehicle due to skidding.

## Causes for poor braking

1. If the brake shoes / pads or drum / disc are worn out or if there is water or oil on them, sufficient friction does not develop and brakes do not work well.
2. Even when the brake works normally, if the road surface is wet or the tyre surface is worn-out, tyres do not take a firm hold on the surface, increasing the stopping distance.
3. Approximately 60% braking effect is from front brake. **Non-usage of front brake causes poor braking.**

### Warning

*As the vehicle speed increases, the stopping distance also increases progressively. Be sure that, you have sufficient distance between you and the vehicle or obstruction ahead of you.*

*Using only the front or rear brake is dangerous and can cause skidding and loss of control. Apply both the brakes together and with great care on a wet road or other slippery surfaces. Any abrupt braking on slippery or irregular roads can cause loss of rider control.*

## ACCESSORY INSTALLATION AND SAFETY TIPS

Use extreme caution while selecting and installing the accessories for your scooter.

The addition of **unsuitable accessories can lead to unsafe operating conditions.** Your friendly Dealer will assist you in selecting quality accessories and installing them correctly.

While selecting the accessories, make sure that the accessories **should not obstruct lighting, steering, suspension level and ground clearance.**

**Additional electrical equipment is not acceptable as it will void the warranty terms of the vehicle.**

## EMISSION CONTROL

All the TVS vehicles are tested in the factory for optimum fuel efficiency and CO levels. If the vehicle needs any adjustments, please consult nearest TVS Motor Company Authorised Main Dealer or Authorised Dealer.

While adequate care is exercised at the factory to ensure that the emissions are within the limits, it is essential for the owner to always maintain the scooter in good condition by getting it periodically checked and serviced by TVS Motor Company Authorised Main Dealer / Authorised Dealer so that the emission and fuel consumption levels are maintained as per norms.

### Crankcase emission control system

The engine of new TVS NTORQ 125 Race XP is equipped with a closed crankcase system to prevent discharging crankcase emissions into the atmosphere. Blow-by gas is returned to the combustion chamber through the air cleaner and the fuel system.

## Evaporative Emission Control System

TVS NTORQ 125 Race XP is equipped with an evaporative emission control system which consists of a canister and associated piping. This system prevents the escape of fuel vapors from the fuel tank.

### Warning

*If there is any abnormal jerk, startability issue are felt in the vehicle or noise due to sudden escape of gas during opening of fuel tank cap, immediately report to the TVS Motor Company Authorised Main Dealer / Authorised Dealer.*

### Note

***Your vehicle is tested and certified for emission which meets BSVI emission norms and is valid for initial 12 months from the date of purchase. Get your vehicle certified by the Government authorised emission testing station after initial 12 months of usage. And ensure to get the vehicle certified on expiry of the certificate obtained.***

***Fill fuel to the marked reference as mentioned in warning sticker, to ensure proper functioning of Evaporative Emission Control system.***

### VEHICLE IDENTIFICATION NUMBER

The frame and engine serial numbers are the only means of identifying your vehicle from others of the same model and type. They are also required to assist your Dealer for ordering parts or referring to special information.



The frame serial number is stamped on the frame, at the rear end below the seat assembly. Open the seat assembly to read the frame number.



The engine serial number is stamped on the left side of the engine, at the bottom, near center stand mounting. See bottom to read serial number.



## LOCATION OF PARTS - HANDLE BAR



1. Connected instrument cluster
2. Engine kill switch
3. Rear view mirror R
4. Right hand brake lever
5. Throttle grip
6. Hazard switch
7. Electric start / mode selection / voice assist switch
8. Ignition cum steering lock
9. Bag hook (front)
10. Horn switch
11. Turn signal lamp switch
12. Left hand brake lever (SBS)
13. Rear view mirror L
14. Parking brake (rear brake lock)
15. High/low beam cum pass by switch

## LOCATION OF PARTS - VEHICLE LEFT SIDE



1. Disc plate front
2. Front wheel axle
3. Caliper assembly front
4. Side stand
5. Pillion foot rest L
6. Rear brake adjuster nut
7. Kick starter lever
8. Lady foot rest - foldable\*
9. Seat cum fuel tank lock

\* Mandatory accessory will be charged extra

## LOCATION OF PARTS - VEHICLE RIGHT SIDE



1. Seat assembly
2. Muffler assembly
3. Gauge oil level
4. Pillion foot rest R
5. Cover front
6. Bag hook (rear)
7. Front wheel axle nut

## LOCATION OF PARTS - VEHICLE FRONT & REAR



### FRONT

1. Head lamp assembly
2. DRL
3. Turn signal lamp front R
4. Turn signal lamp front L

### REAR

1. Tail / brake lamp
2. Turn signal lamp rear R
3. License plate lamp
4. Transmission oil level screw
5. Turn signal lamp rear L
6. Pillion handle

*License plates are mandatory accessory will be charged extra*

## CONTROL KEY

TVS NTORQ 125 Race XP comes with a pair of identical control keys. These keys are to operate ignition cum steering lock, fuel tank cap and seat lock.

### IGNITION CUM STEERING LOCK

The ignition lock enables and disables the electrical circuit and steering lock. The three positions of the lock are described below.

#### 1. 'OFF' position

All the electrical circuits are turned 'OFF' in this position. Engine will not start. Key can be taken out.

#### 2. 'ON' position

In this position, all the electrical circuits are turned 'ON' and the engine can be started now. Key cannot be removed in this position.

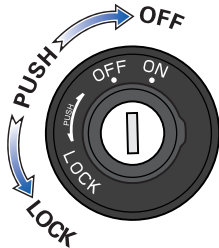

Ensure that the engine kill switch is in 'RUN' mode before starting the engine after the ignition ON. The connected instrument cluster and warning lights perform the self-diagnostic cycle once upon activation.

#### 3. 'LOCK' position

TVS NTORQ 125 Race XP steering can be locked in both 'left' and 'right' directions.

Turn the handlebar to the 'left' or 'right'. Press the key 'IN' and rotate it to the 'LOCK' position from 'OFF' position. All electrical circuits are deactivated and the steering is locked. The control key can be removed from the lock.

**Insert the key into the lock and press the key 'IN' and turn it to 'OFF' or 'ON' position to unlock the steering.**

#### Note

*When you switch on the key, the pump priming noise may be heard, which is normal. Avoid frequent SWITCH-OFF & ON of ignition key, to avoid unnecessary run of fuel pump.*

*By default when the scooter is switched ON for the first time, it starts with 'Street Mode'.*

## Note

The connected instrument cluster background illumination, day time running lamp (DRL) and tail lamp glow automatically once the ignition key is turned 'ON' without activating any other switches. When the ignition switch is turned 'ON' the connected instrument cluster performs self diagnostic cycle. Wait till the message 'HELLO RIDER' or name of the person given in the app is displayed.

## Warning

Never attempt to move the vehicle when the steering is locked, you may lose balance.

## Caution

Leaving the ignition cum steering lock in 'ON' position for a prolonged time will drain the battery when the vehicle is not in use. Switch 'OFF' and take the control key out when the vehicle is not in use.



Always lock the steering while parking for safety.

## HANDLE BAR LEFT SIDE

### 1. Horn switch

Press the switch '  ' to operate the horn.

### 2. Turn signal lamp switch

Slide the turn signal lamp switch to left '  ' or right side '  ' to operate respective turn signal lamps (LH / RH). Press the center button of the switch to turn 'OFF'.

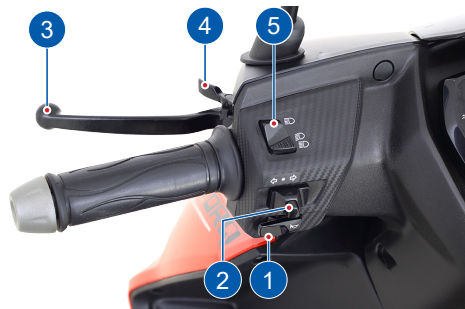

## Warning

Always use the appropriate turn signal lamps when you intend to change lanes or take turns. Be sure to switch it 'OFF' after negotiating the lanes or turns.

### 3. Left hand brake lever (SBS brake lever)

Synchronised Braking System (SBS) can be operated by pressing the left hand brake lever gently towards the handle grip. SBS technology helps to operate both front and rear brakes by distributing the force optimally between the two braking system.

### 4. Rear brake lock lever

Brake lock protects your vehicle from rolling-off, when parked on side stand (or) helps you to relax while waiting in a long traffic signal (or) a slope.

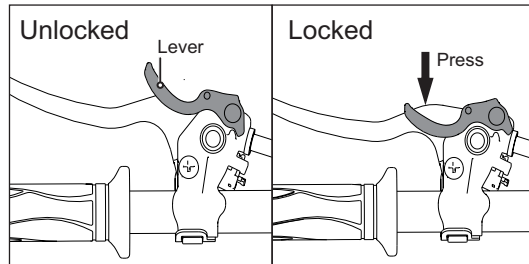



#### **Warning**

Since your vehicle is fitted with SBS brake system it is essential to maintain the brake system in good condition. Adjust the brakes system at regular intervals for the proper working of SBS.

To activate brake lock, press the brake lever almost half towards the grip and hold, then press the parking brake lever to maximum and release the brake lever slowly. Ensure the brake is locked properly. Pressing the brake lever further releases the brake lock automatically.

### 5. High/low beam cum pass by switch

With the head lamp 'ON' (incase of Race edition, headlamp gets on automatically once the engine is started), press the switch towards '  ' to operate head lamp high beam or press it towards '  ' to operate head lamp low beam.

TVS NTORQ 125 Race XP has a combined switch for head lamp 'high / low' beam and pass by. To operate the pass by, keep the switch in 'low beam' position, press gently and release. This makes the head lamp high beam to flash and signal the approaching vehicle. The pass by signal can be used while overtaking during day time.

#### **Warning**

Ensure brake lock is released before riding the vehicle.

Use appropriate head lamp beam 'high / low' as per the traffic and road conditions for your safety and avoid inconvenience to other riders.

## HANDLE BAR RIGHT SIDE

### 1. Right hand brake lever

In case of disc brake vehicles the right hand brake lever controls a hydraulic circuit while squeezing and the hydraulic circuit operates the front brake system. Else the brake system works directly. The brake lamp glows on application of front brake.

### 2. Throttle grip

Engine speed is controlled by the rotation of the throttle grip. Twist it towards you to increase the engine speed and twist it away from you or release it to decrease the engine speed.



### 3. Hazard switch

Whenever it is necessary to park the scooter in a hazardous location due to emergency situation, press the hazard switch to '▲' position with the ignition 'ON' condition. This makes all the turn signal lamps to flash simultaneously to make other road users aware of presence of the vehicle.

#### Warning

*Usage of hazard switch in engine 'OFF' condition can lead to battery drain and can affect the electric startability of the vehicle.*

### 4. Electric starter / mode selection / Voice assist switch

Retract the side stand and press the starter switch '⊗' to start the engine electrically along with the application of either front or rear brake.

Once the vehicle is started (engine is ON) the same switch can be used to change the 'MODE' or to activate the voice assist '⊗'.

Simple short press or tap (<1 sec) of the switch activates the voice control when your smart phone is connected with your instrument cluster and a little long press (>2 sec) of the switch changes the ride mode.



## Note

When the engine is not started the 'Electric starter / mode selection switch' used for start the engine electrically. Once the engine is started the switch is used to activate the voice assist or to change the ride mode.

Voice Assist will only activate when there is a audio device connected with your mobile phone and paired with TVS Connect App. Audio device can be connected by wire or wireless bluetooth headphone.

## 5. Engine kill switch\*\*

Engine kill switch is used to switch 'OFF' the engine but to keep the other DC system active. With the ignition 'ON' condition, keep the switch in ' ' position to turn 'OFF' engine alone. Keeping the switch in ' ' position disables the ignition circuit and prevents the engine from being restarted.

To restart the engine, position the switch to the ' ' position.

## Note

Before starting, ensure to turn 'ON' the engine kill switch and retract the side stand. Release the electric starter switch immediately after the engine has started.

## CONNECTED INSTRUMENT CLUSTER

Your TVS NTORQ 125 Race XP is provided with a fully digital connected instrument cluster with lots of features and various modes like 'STREET' mode, 'RACE' mode, mobile app for Android™ / iOS devices and navigation assist etc.

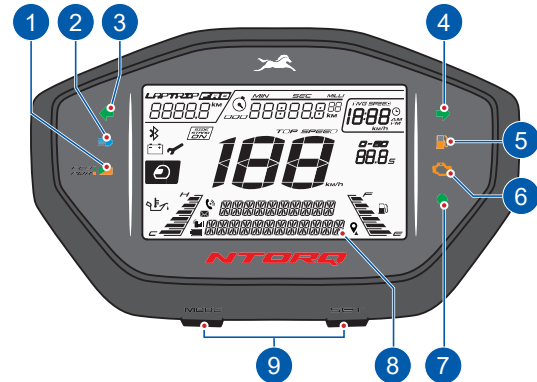

### 1. Economy and power indicator

Eco indicator (green lamp) indicates that the vehicle is running in economy mode which gives better fuel economy.

Power indicator (amber lamp) indicates that the vehicle is running in power mode which results in reduced fuel economy.

Power indicator will also glow if engine is stalled using kill switch.

### Note

*Always ride the vehicle in 'Economy Mode' for better fuel efficiency.*

*Whenever the engine is kept running in idle mode for more than 20 seconds approximately, the power mode indicator blinks and informs you that the fuel is getting wasted and the engine needs to be switched 'OFF' to save the fuel and the power mode indicator blinking (power mode) to green light glowing (economy mode) when the throttle position is changed / increased.*

### 2. High beam indicator lamp ( )

Glowes when the head lamp is activated in high beam or pass-by condition.

### 3. Turn signal indicator left ( )

Flashes when the 'left' side turn signal indication is activated.

*\* Mis-firing detection is applicable only for OBD II vehicle.*

### 4. Turn signal indicator right ( )

Flashes when the 'right' side turn signal indication is activated.

### 5. Low fuel indication ( )

The low fuel indicator glows when the fuel level goes down and a warning message 'FUEL EMPTY' will be displayed continuously in the alpha numeric display.

**When the fuel level reaches very low level the message 'FUEL EMPTY' starts blinking for the user's attention to refill the fuel.**

FUEL EMPTY

### Caution

*When the low fuel warning indicator lamp glows fill fuel in the fuel tank immediately to avoid engine switch 'OFF' / damage to fuel pump which leads to replacement of pump without warranty.*

### 6. Malfunction indicator lamp - MIL ( )

The MIL indicator will be turned 'ON' whenever the ECU detects a fault in the system (general warning) and the MIL indicator will blink for the fault whenever it is required the user to take action immediately (hazard warning / misfiring warning\*).

If the malfunction indicator lamp '' is glowing continuously or blinking continuously when the engine is started, immediately contact the nearest TVS Motor Company Authorised Main Dealer or Authorised Dealer.

### Note

*The malfunction indicator will continue to remain switched 'ON' after self checking of cluster until the engine is started. But after starting the engine it will get switch 'OFF' if no malfunction is detected.*

### 7. Smart-connect notification LED (●)

**A green colour LED indicator glows** and indicates whenever there is an incoming call or message received by the 'Smart Phone' paired with your TVS NTORQ 125 Race XP.

This indicator will go 'OFF' once the user read the message / incoming calls details.

### 8. Alpha numeric display

The customized alpha-numeric display indicates different modes of instrument cluster, vehicle information and Smart-connect related messages, when the ignition key is turned 'ON' and vehicle running condition. Ride mode display change is possible after engine 'ON' only.

### 9. Mode and Set buttons

Mode button is used to change the connected instrument cluster's display to various modes like 'Street mode', 'Race mode', 'Ride stats mode', for clock setting and Bluetooth pairing etc.

Set button is used to 'Set' or 'Erase the stored value' in various modes.

The set button is also used to find the estimated time of arrival, clock setting, Bluetooth pairing and distance remaining to reach the destination in navigation mode.

When the MODE button in the instrument cluster is pressed, the mode change will happen ie. when the display is in Street mode, if the MODE button is pressed, it will change to Race mode and the vice-versa is also applicable.

The mode change via instrument cluster is possible even with the engine 'OFF' condition. Even if the engine is not started, the mode change is possible via MODE button.

If the vehicle speed crosses 2 kmph, then mode change will not be possible using mode button.



TVS Ntorq 125 Race XP's connected instrument cluster offers you different modes of display to choose.

1. Street mode
2. Race mode
3. Ride stats mode
4. BT pair mode
5. Set clock mode

In the above, Street and Race modes are ride modes that can be accessed by various input methods. But others can be accessed using only the Mode button of instrument cluster. The sequence of the modes, their selection and their working are explained in the following pages.

### Note

Except Street and Race mode, all other mode changes are possible only when the vehicle is in static for safety. In BT pair mode, throttle shall be raised 0-2 Km/h to see the ride MODE display after engine 'ON'.

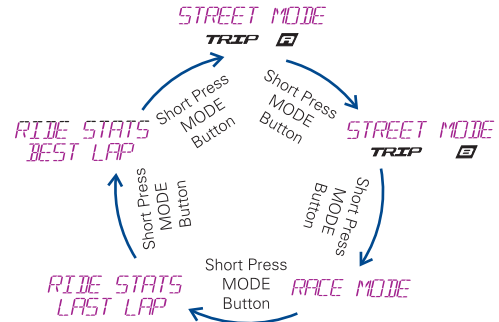

### Note

Changing mode (Street to Race or vice versa) using mode switch in instrument cluster will also result in changing of mode in the vehicle.

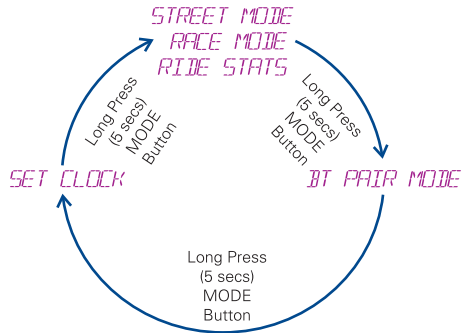

### Note

Only Street mode and Race mode will be displayed in the instrument cluster during vehicle run. All other modes can be accessed only when the vehicle is static.

On ignition 'OFF' and 'ON', the previously displayed mode will be retained in display of the connected instrument cluster.

### Note

The connected instrument cluster of your scooter enters into BT pair mode automatically, when the following conditions are met:

1. Battery is disconnected and reconnected again.
2. When the vehicle fuse is blown and replaced.
3. When the electric start is done with the low SOC (state of charge) battery (will be indicated through self-check of connected instrument cluster).

## RIDE MODES

There are two ride modes are there in your scooter:

- Street mode
- Race mode

For city drive conditions, Street mode is recommended. For highway drive conditions, for better performance and for powerful ride, Race mode is recommended.

The following are the ways to change the ride modes of your scooter:

- Short press of ES switch (refer page 26)
- By pressing MODE button (refer page 29)
- By pressing the STREET or RACE tab in your live dashboard of App (refer page 51)
- By using Voice assist (refer page 52)

### Note

*If there is error in the scooter ie. if the MIL is ON, then it is not possible to change the modes. Similarly, the mode change will not happen if the vehicle speed is greater than 85 kmph. In error condition, by default, it will be in Street mode.*

*If you are in Street mode at 80 kmph, there will be a recommendation to change to Race mode in the instrument cluster.*

## 1. Street mode

In street mode, the following features will be displayed on the connected instrument cluster:

- 1a. Odometer
- 1b. Digital clock
- 1c. Shortest time indicator
- 1d. Fuel gauge
- 1e. Speedometer
- 1f. Engine temperature gauge
- 1g. Helmet icon
- 1h. Low battery indicator
- 1k. Service reminder
- 1m. Trip A, B and F
- 1n. Side stand indicator

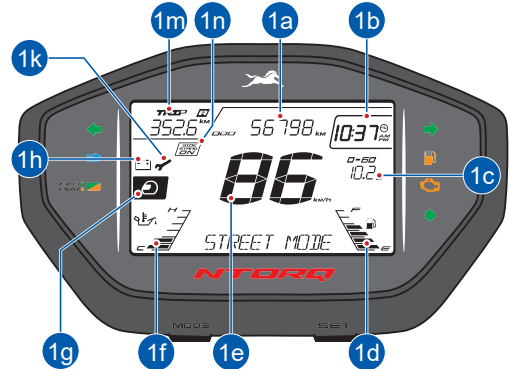

### 1a. Odometer

Odometer registers the total distance covered by the vehicle in kilometer.



### 1b. Digital clock

Indicates the time in 12 hour format (AM or PM).



### Note

*If the battery is disconnected and reconnected during service, you may need to reset the time as explained in page no. 46.*

*Otherwise the clock timing will be set automatically as per the connected mobile device after completion of successful Bluetooth pairing when auto sync clock is enabled in App.*

### 1c. Shortest time indicator



Shortest time indicator records the minimum time taken to reach 60 km/h from start. The timer starts once the vehicle speed crosses 2 km/h and the time will be displayed on crossing 60 km/h speed.

### 1d. Fuel gauge

Digital bars indicates the approximate quantity of fuel available in the fuel tank. There are six bars to indicate the quantity of fuel available in the tank.



All the six bars will be displayed when the fuel in the tank reaches above 5 liters approximately (full tank). When the fuel reaches half tank (3.2 liters approx.) the fuel gauge displays only three bars as shown.



When the fuel reaches minimum safe level (1.2 liters approx.), the last bar of the fuel gauge starts blinking and low fuel indicator starts glowing. The message 'FUEL EMPTY' will be displayed at alpha numeric display and 'TRIP F' meter starts counting from 0.0 km as explained in page no. 36.



**Note**

If all the fuel level bars of the connected instrument cluster are blinking and an error message 'CHECK FUEL SENSOR' displayed at alpha numeric display as shown, Contact nearest TVS Motor Company Authorised Main Dealer / Authorised Dealer.

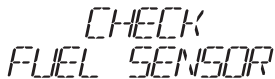

**Note**

Fuel level shown is only for reference purpose and users are not encouraged to calculate mileage of the vehicle using the same.

**1e. Speedometer**

Indicates the vehicle speed in kilometer per hour by default when the ignition is turned ON.



**1f. Engine temperature gauge**

The temperature gauge displays the engine temperature in digital bars. There are six bars to indicate the engine temperature. All the six bars will be displayed if the engine temperature raises beyond normal operating temperature and a diagnostic message 'ENGINE WARNING' also will be displayed at the alpha numeric display as shown.





On occurrence of the above error message, the vehicle should be kept in idling for 10 minutes approx. and switch 'OFF' the vehicle. If the problem continues even after cooling the engine, take the vehicle to TVS Motor Company Authorised Main Dealer or Authorised Dealer and get it rectified.

### 1g. Helmet icon

With every ignition 'ON', Helmet icon '' blinks for 10 seconds on the left side of the connected instrument cluster to remind the rider to wear a helmet.

### 1h. Low battery indicator

An icon with battery symbol '' glows when the battery charge is too low. Get the battery checked at TVS Motor Company Authorised Main Dealer / Authorised Dealer.

### Note

*Low battery and service reminder indicator works on all the modes of the connected instrument cluster.*

### 1k. Service reminder

If the service is due, whenever the ignition is turned 'ON', a icon with spanner symbol '' blinks for 10 seconds after the self-check cycle of connected instrument cluster and continue to glow till the vehicle is serviced and the reminder is reset. Get the vehicle serviced at TVS Motor Company Authorised Main Dealer / Authorised Dealer.

### 1m. Trip A and B

Trip meter indicates the trip distance traveled in kilometer. The digit after the dot mark denotes one tenth of a kilometer.

TRIP   
630.6<sup>km</sup>

TRIP   
510.6<sup>km</sup>

Provision is provided for the users to measure two different distances as per their convenience. In street mode, 'TRIP A' will be displayed by default. Press mode button once to enter 'TRIP B'. To reset any of the trips (A or B), press the 'SET' button more than 3 seconds while display is in the respective trip in vehicle static condition only.

## Trip F



This function shows the distance traveled after the low fuel indication symbol (  ) is 'ON' and 'FUEL EMPTY' message displayed at alpha numeric display. The display switches automatically to 'TRIP F' once the low fuel indication is 'ON' and starts counting from 0.0 km.

If the fuel level remains in minimum safe (reserve) level, the reading will be saved even after the ignition 'OFF'.

The 'TRIP F' meter stops counting and gets cleared automatically once the fuel is filled above minimum safe (reserve) level which is indicated by at-least 2 bars in the fuel gauge. Once TRIP F is cleared, Trip A / B display switches ON automatically.

**Please remember that the 'TRIP F' meter cannot be activated or deactivated manually and can't be reset.**

On every ignition ON, 'TRIP F' meter will get enabled automatically until fuel level raises above minimum safe level. 'TRIP A' and 'TRIP B' will still be accessed by short pressing the 'Mode' switch but the display will automatically enter 'TRIP F' after 5 seconds.

## 1n. Side stand indicator\*\*

The side stand warning indicator turns 'ON' to alert you whenever the vehicle's side stand is deployed (vehicle parked condition).



### Note

*If the side stand is deployed the vehicle will not start. Retract the side stand to start the vehicle.*

*If there is error in the side stand sensor the indication will not blink and the vehicle will not start. In such a condition, please visit the nearest TVS Motor Company Authorised Main Dealer / Authorised Dealer.*

## 2. Race mode

To enter into Race mode, short press the 'Mode' button in street mode while 'Trip B' in display.

In sport mode, the following features will be displayed on the connected instrument cluster:

- 2a. Lap distance
- 2b. Lap timer
- 2c. Shortest time indicator
- 2d. Speedometer (refer page no. 34)

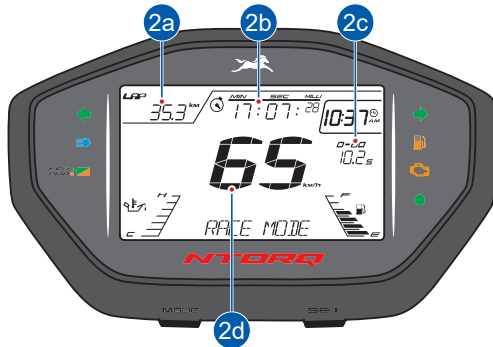

### Note

One lap is considered from one ignition ON to OFF.

## 2a. Lap distance

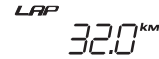

The total distance covered by the vehicle in a particular lap will get captured in 'Lap distance' counter. Once the vehicle speed crosses 2 km/h, the lap distance counter starts counting distance automatically and stops when the speed goes below 2 km/h. If the speed increases again, the counter continues the distance counting. The lap distance counter ends when the ignition is turned 'OFF'.

## 2b. Lap timer

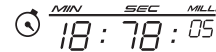

Lap timer is the total time taken by the vehicle for completing a single lap.

Similar to lap distance, the lap timer also starts once the vehicle speed crosses 2 km/h and stops when the speed goes below 2 km/h indicated by blinking of lap timer '🕒' icon. If the speed increases again, the timer continues counting. The lap timer ends when the ignition is turned 'OFF'.

## 2c. Shortest time indicator

0-60  
10.7<sub>s</sub>

Shortest time indicator records the minimum time taken to reach 60 km/h from start. The timer starts once the vehicle speed crosses 2 km/h and the time will be displayed on crossing 60 km/h speed.

### Note

Shortest time indicator data will be displayed only if the time taken to reach 0 to 60 km/h is less than 15 seconds. If the time taken is more than 15 seconds then the default time (15 seconds) will be displayed.

The values of sport mode can be reset by pressing 'SET' button for more than 3 seconds in vehicle static condition only.

The value of shortest time indicator disappears automatically if the vehicle speed reduces below 2 km/h.

## 3. Ride stats mode

To enter into ride stats mode, short press the 'Mode' button in sport mode when the vehicle is static. Following two features are available in ride stats mode.

- 3.1. Ride stats last lap
- 3.2. Ride stats best lap

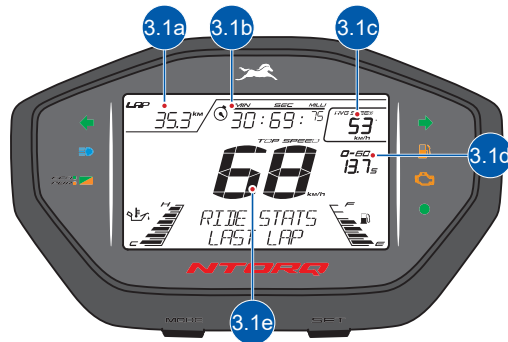

### Note

In this mode, if the vehicle speed crosses above 2 km/h, the connected instrument cluster enters to 'STREET MODE' automatically.

### 3.1. Ride stats last lap

'RIDE STATS LAST LAP' appears by default on entering ride stats mode. The details displayed in this mode are as given below :

- 3.1a. Previous lap distance
- 3.1b. Previous lap timer
- 3.1c. Previous lap average speed
- 3.1d. Previous lap shortest time
- 3.1e. Previous lap top speed

#### 3.1a. Previous race lap distance

Previous race lap distance is the total distance covered by the vehicle in the last lap.

#### 3.1b. Previous race lap timer

Previous race lap timer is the total time taken by the vehicle to complete the last lap.

#### 3.1c. Previous race average speed

Previous race average speed is the average speed of vehicle traveled during last lap.

#### 3.1d. Previous race shortest time

Previous race shortest time is the shortest time taken to reach 0 to 60 km/h in the last lap. If there are more than one record in the same lap, the best value will be displayed.

### 3.1e. Previous race top speed

Previous race top speed is the top speed that the vehicle has achieved during last lap.

#### Note

*All the above details are recorded only when the vehicle is driven in sport mode.*

*All the above values can be reset by pressing the 'Set' button for more than 3 seconds in vehicle static condition.*

### 3.2. Ride stats best lap

To enter 'RIDE STATS BEST LAP' mode, press 'MODE' button once in 'RIDE STATS LAST LAP'. The details in this mode are as given below :

- 3.2a. Best average speed
- 3.2b. Best lap timer
- 3.2c. Best lap distance
- 3.2d. Best top speed
- 3.2e. Best shortest time

#### 3.2a. Best average speed

'Best average speed' is the best average speed amongst the previously concluded laps.

### 3.2e. Best lap timer

'Best lap timer' is the total time taken by the vehicle corresponding to the best ever average speed.

### Note

*All the above values can be reset by pressing the 'Set' button for more than 3 secs in vehicle static condition.*

### 4. BT pair mode

This mode can be entered by pressing 'MODE' button for 5 secs from STREET / RIDE mode.

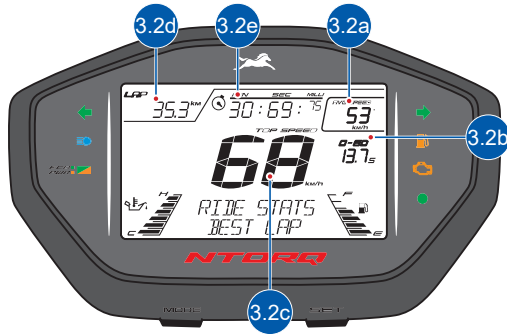

### 3.2b. Best shortest time

'Best shortest time' is the shortest time taken ever to reach 0 to 60 km/h speed since the time of vehicle purchase or since last reset.

### 3.2c. Best top speed

'Best top speed' is the highest speed that the vehicle has reached since the time of vehicle purchase or since last reset.

### 3.2d. Best lap distance

'Best lap distance' is the total distance covered by the vehicle corresponding to the best ever average speed.



The connected instrument cluster of your TVS NTORQ 125 Race XP can be connected to your Android™ smart phones and iPhone® via Bluetooth® through a **TVS CONNECT** app which can be downloaded from Google Play and the App Store®.



### TVS CONNECT

#### Note

*In this mode, if the vehicle speed crosses above 2 km/h, the connected instrument cluster will enter to 'STREET MODE' automatically.*

*Any number of Android phones can be auto-paired with the instrument cluster.*

*Only one iPhone can be auto-paired with a single instrument cluster at a time. If the user need to connect multiple iPhones with the single instrument cluster, the previous connected iPhone has to be forgotten by clicking, "Forget This Device" from Bluetooth settings in the iPhone.*

#### Note

*If the vehicle battery is reset or fuse is blown, then too "Forget This Device" from Bluetooth settings in the iPhone has to be done.*

#### Steps to "Forget This Device" in iPhone:

If the user needs to connect multiple iPhones with the single instrument cluster, the previous iPhone has to be forgotten using "Forget This Device" from Bluetooth settings in the following manner:

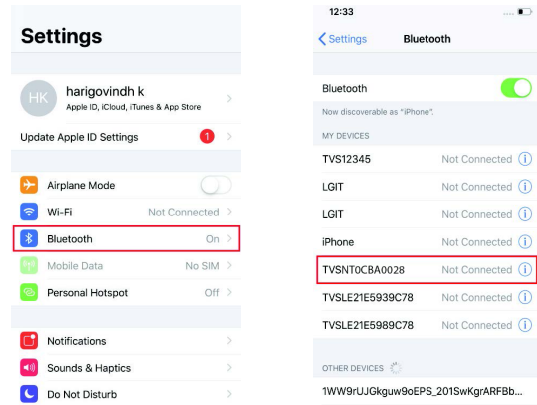

1. In the previous connected iPhone, open the SETTINGS -> BLUETOOTH.
2. Select the instrument cluster, which was connected previously.
3. Click on the "Forget this device"

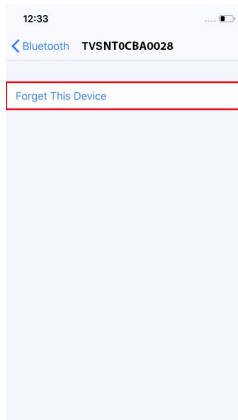

### First time Bluetooth pairing:

To pair your Android smart phone or iPhone with your TVS NTORQ 125 Race XP's connected instrument cluster, via Bluetooth, for the first time, follow the procedure as described below :

1. Switch 'ON' the vehicle.
2. Speedometer can be in any mode for first time pairing.
3. Open the app and press "**CONNECT**", ensure the smart phone is near to the vehicle.
4. The app searches for all Bluetooth devices nearby and displays the list of devices available.

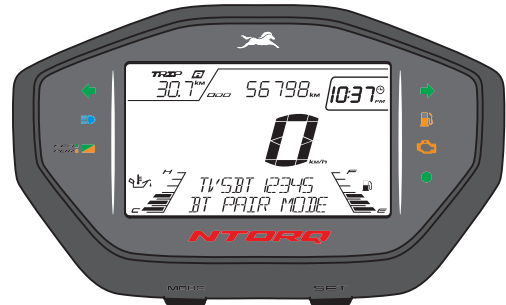



5. The connected instrument cluster's Bluetooth name is prefixed by TVSBT and followed by alpha-numeric digits. Ex : 'TVSBT12345'. This Bluetooth name can be found by changing the cluster mode into BT pair mode.
6. Now, select the 'TVSBT12345' in app to initiate the pairing process.
7. On pairing, the alpha-numeric display of connected instrument cluster displays 'CONNECTION SUCCESSFUL' message for 3 secs and a Bluetooth icon ' ' will be displayed on the speedometer. Additionally phone's battery icon and signal strength icon will be displayed on connected instrument cluster.

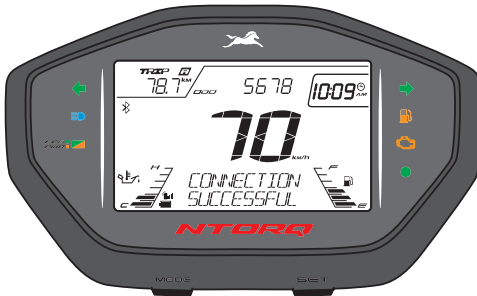

8. For initiating first time pairing, logout from the app, login again using your login credentials and then press CONNECT.

### Note

*During the course of pairing process, if there is any occurrence of error, the connected instrument cluster should be turned 'OFF' and 'ON', and the application also need to be restarted.*

*Please remember that, all the smart phones are not compatible for pairing with the TVS NTORQ 125 Race XP's connected instrument cluster.*

*During the search of Bluetooth devices in app, if the vehicle connected instrument cluster's Bluetooth device ID is not visible, try for one or two more iterations.*

## Auto pairing

Once the first time pairing is done between vehicle's instrument cluster and your smart phone, the phone will automatically pair with the vehicle when the following conditions are met :

1. Vehicle is switched 'ON' and vehicle is near to the smart phone.
2. Smart phone's Bluetooth is turned 'ON'
3. First time pairing is ensured.
4. In case of iPhone, the TVS CONNECT app should be open or be open in background for auto-pairing to happen.

Every time auto-pairing happens, app will open automatically and connect with the Instrument cluster. The connected instrument cluster shows 'CONNECTION SUCCESSFUL'

CONNECTION  
SUCCESSFUL

If your smart phone is disconnected from the vehicle's instrument cluster then Ex: 'JOHN DISCONNECTED' message will be displayed on the alpha-numeric display of connected instrument cluster.

JOHN  
DISCONNECTED

## Note

*If the phone enters battery saver mode, auto-pairing might not happen. It takes maximum of five minutes for auto-pairing and it can happen in vehicle running or engine at idling or engine off condition.*



*Auto-pairing happens only if the application is locked in the RAM in multitasking screen of the phone with manufacture's customized OS (Ex : MI, Vivo etc.)*

*In case of Android phones with Android OS version above 8.0, for App to work seamlessly, any battery optimization setting to be removed in the TVS Connect App and GPS shall be allowed to run in background in high accuracy mode.*

*Even if your phone's Bluetooth is already paired to other gadgets like smart watch, health band or helmet, the auto-pairing works with your TVS NTORQ 125 Race XP 's connected instrument cluster.*

*If the application unfortunately stops due to unforeseen circumstances, close and reopen the application and do the manual pairing for the first time, then auto pairing will happen subsequently.*

*For first time pairing, logout from the app, login again with your login credential and press CONNECT button.*

Once the connected instrument cluster of your TVS NTORQ 125 Race XP is connected with your smart phone, the connected instrument cluster displays Bluetooth '  ' icon, your mobiles battery level '  ' icon and network providers signal strength '  ' icon.

### Note

*Incase multiple SIM cards are used in smart phone, by default, SIM 1's network provider's signal strength is shown in the display of connected instrument cluster.*

*Signal strength displayed in connected instrument cluster might vary from the display in smart phone as the former is referred from telephonic standards.*

### Incoming call alert display ' '

The connected instrument cluster will display the incoming calls alerts from the smart phone via Bluetooth. Ex. 'CALL FROM AMIT', will be displayed if the contact is stored in the smart phone's otherwise number will be displayed. Ex. 'CALL FROM 9863571861'. The notification smart-connect notification LED (green LED) starts blinking on receiving the incoming call till the call is active.

CALL FROM AMIT      CALL FROM 9863571861

### Missed call alert display ' '

The connected instrument cluster displays the total number of missed calls from the smart phone via Bluetooth 10 seconds approx., Ex. '3 MISSED CALLS'.

 03  
MISSED CALLS

## Note

Number of missed calls (inclusive of user rejected calls) will be displayed at the end of each incoming call and it will be reset once a trip is completed and a trip report is generated in app or if app is closed.

## SMS alert display '✉'

The connected instrument cluster displays the incoming SMS from the smart phone via Bluetooth, Ex. 'SMS FROM AMIT', name of the sender will be displayed. The connected instrument cluster displays incoming SMS only if the number is stored in the contact list.

✉ SMS FROM  
AMIT

## Note

The SmartXonnect Notification LED (green LED) blinks for five seconds approximately whenever there is a incoming message.

SMS alert display is not applicable for iPhones.

## 5. Set clock mode

To enter the set clock mode, press 'Mode' button for more than 5 secs in Bluetooth pairing mode. The digital clock starts blinking once the connected instrument cluster enters the set clock mode.

- Press the 'Mode' button while the digital clock is blinking. The hour digits of clock starts blinking and enables you to change the hours.
- Press the 'Set' button to increase the hours while hour digits are blinking.
- On pressing the 'Mode' button again the hours gets set and the minute digits starts blinking.

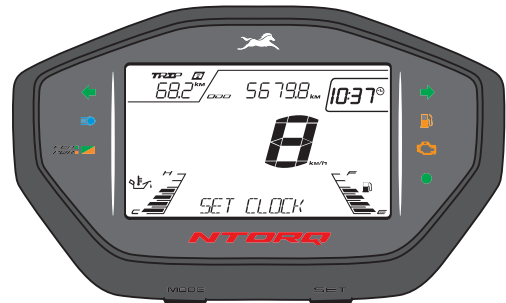

- Now, press the 'Set' button to increase the minutes while minute digits are blinking.
- Once again press the 'Mode' button so the minutes of the clock is set and the hours format 'AM' or 'PM' starts blinking.
- Press the 'Set' button to change the hour format either to set 'AM' or 'PM'.
- Press the 'Mode' button once again to set clock and wait for 5 secs to come out of set clock mode.

### Note

*In this mode, if the vehicle speed crosses above 2 km/h, connected instrument cluster will enter to 'STREET MODE' automatically.*

*If no input is given for more than 5 secs while the set clock mode is in operation, the connected instrument cluster comes out of this mode automatically.*

*The clock time gets sync automatically on paring your Android smart phone with the connected instrument cluster provided if auto sync clock setting is enabled in app.*

### TVS CONNECT APP



Dedicated smart phone app is available in the Google Play and the Apple store for your 'TVS NTORQ 125 Race XP' and it can be installed in your Android and Apple smart phones. To access the features of your TVS NTORQ 125 Race XP's connected instrument cluster like :

- Incoming call alerts in connected instrument cluster.
- Incoming SMS alerts in connected instrument cluster (applicable only for Android smart phones).
- Number of missed call alerts in connected instrument cluster.
- Battery status of your smart phone in connected instrument cluster.
- To send auto reply SMS to the callers via smart phone (applicable only for Android smart phones).
- "Do Not Disturb" mode during the ride (applicable only for Android smart phones).

- To send navigational assist instructions inputs to the connected instrument cluster from your smart phone.
- To save the last traveled route.
- To locate the last parked location of your TVS NATORQ 125 Race XP.
- To know the signal strength of your mobile network in connected instrument cluster.
- To generate and store Ride reports.
- To sync the connected instrument cluster clock with smart phone clock.
- To control the background illumination of the Instrument cluster.

This dedicated mobile app of your TVS NATORQ 125 Race XP can be downloaded from the Google Play and the App Store® by searching the key word '**TVS CONNECT**' else by scanning the below QR code.

### Note

*This smart phone app is compatible only for the smart phones with Android OS version Kitkat (4.4) and above, iOS version 9 and above and the BLUETOOTH version 4.0 and above. Android and Google Play are trademarks of Google LLC. App Store® and iOS are trademark of Apple.*



*Android*



*iOS*



## How to login

On opening the **TVS CONNECT** app the following introductory screens will be displayed.

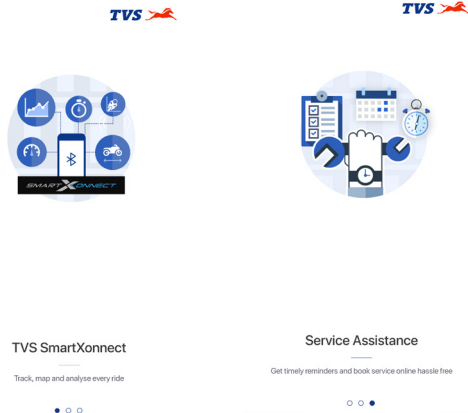

Move to the last screen where you will find the 'SIGN UP' and 'LOGIN' tab. If you are having login already then press login tab. A screen with various login options opens-up as shown.

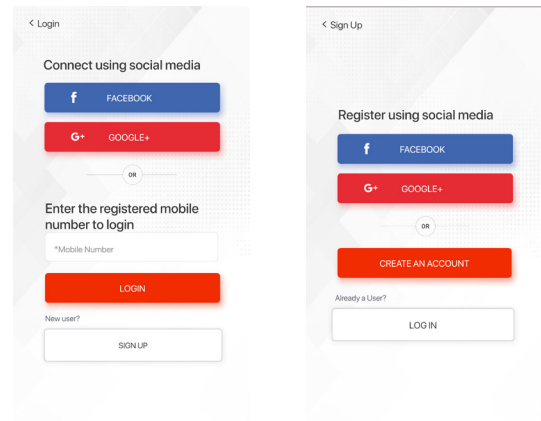

You can login using your social media logins like FACEBOOK and GOOGLE+ or using your mobile number which has been registered already.

If you are a new user then press the sign up tab where you will find various options for registering using your social media logins like FACEBOOK and GOOGLE+ or a tab for creating new account.

Using your social media logins you can create new login else press the 'CREATE AN ACCOUNT' tab.

On pressing the 'CREATE AN ACCOUNT' tab, a screen opens with various input details. Feed in your details and submit. On submitting the details a screen opens with one time password (OTP) entry.

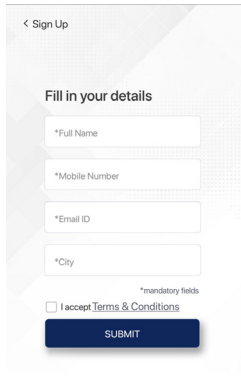

< Sign Up

Fill in your details

\*Full Name

\*Mobile Number

\*Email ID

\*City

\*mandatory fields

I accept [Terms & Conditions](#)

SUBMIT

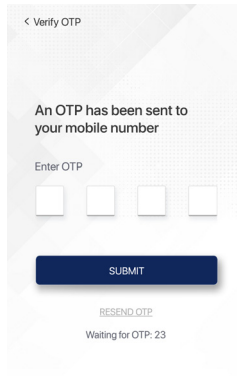

< Verify OTP

An OTP has been sent to your mobile number

Enter OTP

Waiting for OTP: 23

RESEND OTP

SUBMIT

Enter the OTP which is received from TVS Motor Company Limited and submit. On submitting the OTP, another screen opens where you have to enter your vehicle's chassis number for verification.

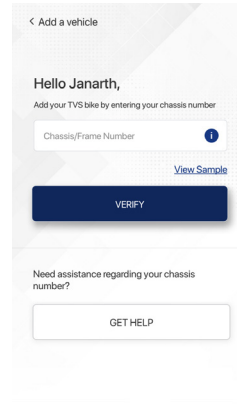

< Add a vehicle

Hello Janarth,

Add your TVS bike by entering your chassis number

Chassis/Frame Number

[View Sample](#)

VERIFY

Need assistance regarding your chassis number?

GET HELP

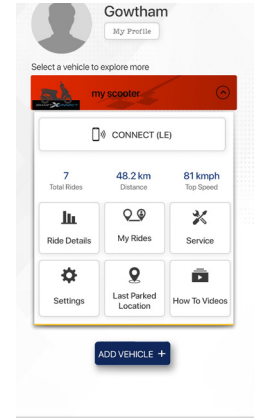

Gowtham

My Profile

Select a vehicle to explore more

my scooter

CONNECT (LE)

7 Total Rides	48.2 km Distance	81 kmph Top Speed
Ride Details	My Rides	Service
Settings	Last Parked Location	How To Videos

ADD VEHICLE +

After successful verification of your chassis number, the Home screen of the app opens.

### Note

*Please remember that the Navigation License has to be renewed after 5 years of vehicle purchase and renewal can be done by contacting near by Dealer end.*



## Add vehicle

Add vehicle tab allows you to add any of your TVS bikes by entering its chassis number. You can have sample view of the frame number and also you can get help by chatting with us or by E-mailing to us or by calling us.

## Vehicle mode change through App

1. After connecting the App to the vehicle, you can see the live dashboard.
2. The vehicle mode can be changed using the 'RACE' and 'STREET' mode button as highlighted below.

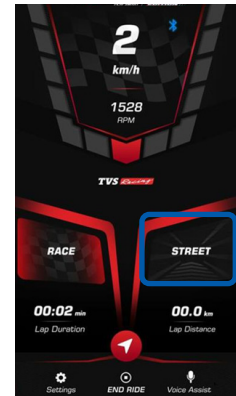
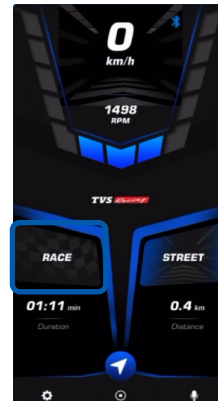

## Voice assist

We have upgraded our electric start switch with an additional function to invoke voice assistant. Once, the mobile app is connected to the Speedometer. There are two ways to invoke voice assist in your scooter:

1. By pressing the Electric start / Mode change / Voice assist switch for >2s, after the engine is started. This method of invoke will only work when engine is 'ON'.
2. By pressing the voice assist icon in the app live dashboard as shown on the image. This will work irrespective of engine is 'ON/OFF'.

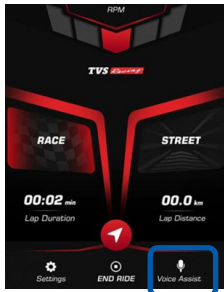

## Note

*Voice assist will work with screen lock condition / app background condition.*

*Use Wired/Wireless headphone for listening and talking.*

*Voice feedback will work only if a wired / wireless headphone is connected.*

*Option to enable/disable voice assistant and voice feedback is available in App settings.*

After invoking voice assist through either of the two ways, "Listening" will appear on the screen and a beep sound will be heard on the headset.

This is when we have to start speaking / providing the command.

The following are the list of intents recognized by voice assist. You can refer page no. "Voice assist commands and key words" on page 54 for sample commands of each intent:

- Greeting command
- Navigation command
- Nearest POI command
- Mode change command – Race / Street modes
- Brightness increase / decrease command
- Current location
- Missed call
- Last call
- Top speed
- Enable / Disable Auto SMS
- Enable / Disable Do Not Disturb
- Enable / Disable High Speed Alert
- Ride start time
- Volume increase / decrease

## Voice assist commands and key words

S. No.	Intent	Commands	Voice Feedback
1	GREETING	Hi buddie	Hello '____'
		How are you doing	
		Hi buddie	
		Hey buddie	
		Hello friend	
		How u doing	
2	NAVIGATION	Go to	Taking you to '____'
		Take me to	
		Let's go to	
		Navigate to	
		Navigate me to	
		Guide me to	
		Show me	
		Take to	
		Directions to	
		Show me Directions to	

S. No.	Intent	Commands	Voice Feedback
3	POI	Near	Taking you to nearest '____'
		Near by	
		Near to	
		Nearest	
4	MODE RACE	Race Mode	Race Mode Activated
		Go to Race Mode	
		Switch to Race	
		Its race time	
		Activate race mode	
		Lets move on to race mode	
		Activate race mode	

S. No.	Intent	Commands	Voice Feedback
5	MODE STREET	So slow	Street Mode Activated
		Turn off race	
		Go to traffic	
		Street Mode	
		Go to Street Mode	
		Activate street mode	
		Switch to Street	
		Switch to Street mode	
6	BRIGHTNESS INCREASE	Brightness Increase	Brightness increased
		Brightness Up	
		Brightness High	
		Increase the speedo brightness	
		Turn up the brightness	
		Turn off night mode	
		Increase the brightness	
		Increase speedo brightness	

S. No.	Intent	Commands	Voice Feedback
7	BRIGHTNESS DECREASE	Brightness decreased	Brightness decreased
		Brightness down	
		Brightness low	
		Reduce the speedo brightness	
		Turn down the brightness	
		Switch the display to night mode	
		Decrease the brightness a bit	
		Decrease the speedo brightness	
		Decrease speedo brightness	
		Go dark	

S. No.	Intent	Commands	Voice Feedback
8	CURRENT LOCATION	My location	You are around ' ____ '
		Where we right now	
		What is the name of this place	
		Where am i right now & how far we are	
		Where am i now	
		What is my current location	
		Show my location	
		Show my current location	
		Show current location	
		Show location	
Where are we right now			





S. No.	Intent	Commands	Voice Feedback
9	CALL MISSED	How many missed calls I have	You have '____' missed call
		Have I missed calls	
		Missed call	
		Number of missed calls	
		Did i get any calls	
		Show me missed calls	
		Update status on the missed call	
10	CALL LAST	Last call	You have last call from '____'
		Who called me last	
		Who called recently	
		Last caller	
		Show my last caller	
		Who is my last caller	

S. No.	Intent	Commands	Voice Feedback
11	SPEED	What is my top speed	Your top speed is ' ____ ' kmph
		My highest speed	
		What is my last high speed	
		Top speed	
		How fast did i go	
		How fast are we	
		Show me the stats for the last ride	
		Tell me the top speed for the last ride	
		Whats my top speed achieved in my last ride	
		What's the top speed we hit toady	
		Show my highest speed	
		Show top speed	
Show my top speed			

S. No.	Intent	Commands	Voice Feedback
12	SETTING AUTO SMS ENABLE	Enable auto sms	Auto SMS reply enabled
		Auto reply SMS ON	
		Auto SMS ON	
		Auto reply ON	
		Enable auto reply	
13	SETTING AUTO SMS DISABLE	Disable auto sms	Auto SMS reply disabled
		Auto reply SMS OFF	
		Auto SMS OFF	
		Auto reply OFF	
		Disable auto reply	

S. No.	Intent	Commands	Voice Feedback
14	SETTING DND ENABLE	Enable do not disturb	Do not disturb setting enabled
		Do Not Disturb enable	
		Do Not Disturb ON	
		Enable DND	
		DND setting enabled	
		DND mode enabled	
		Do not disturb setting enabled	
		Do not disturb mode enabled	
15	SETTING DND DISABLE	Disable do not disturb	Do not disturb setting disabled
		Do Not Disturb disable	
		Do Not Disturb OFF	
		Cut calls while riding	
		Disable DND	
		DND setting disable	
		DND mode disable	
		Do not disturb setting disable	
Do not disturb mode disable			

S. No.	Intent	Commands	Voice Feedback
16	RIDE START TIME	When did I start my ride	Ride Time ' ____ '
		What time I start ride	
		When did we start from home / work	
		Ride start time	
		Show start time	
		Show ride start time	
17	VOLUME INCREASE	Increase volume	Volume Increased
		Volume up	
		Increase sound	
18	VOLUME DECREASE	Decrease volume	Volume Decreased
		Volume down	
		Decrease sound	
		Reduce volume	
19	SETTING HIGH SPEED ALERT ENABLE	Enable high speed alert	High speed alert setting enabled
20	SETTING HIGH SPEED ALERT DISABLE	Disable high speed alert	High speed alert setting disabled

## Note

*The list of commands and intent will be updated periodically. Please refer to the command list mentioned in the mobile app to stay updated.*

### **Things to do while using voice assistant:**

1. We recommend to use ANC (Active Noise Canceling) Bluetooth devices for better performance
2. Ensure Microphone is kept near to your mouth while giving out commands
3. Please ensure that it is not exposed to outside environmental noise such as wind noise, other vehicles' noise etc.
4. We recommend you to go through the sample command list before trying your intent.
5. Kindly refer to the voice feedback of the detected place name when you provide voice command for navigation.
6. Make sure you have the engine running when voice assist is invoked through vehicle switch.

### **Things not to do while using voice assistant:**

1. We recommend you not to use the method of invoking voice assist through mobile App while riding.
2. Please do not use voice assist functionality during heavy traffic condition.

### Smart talk

TVS NTORQ 125 Race XP is equipped with yet another first-in-class feature – Smart talk.

Smart talk feature communicates from vehicle to customer of either critical parameters like fuel level or achievements done like top speed achieved as shown below:

SI. No.	Smart talk feature	Voice feedback	Display in cluster
1	Top Speed	Top Speed Achieved	TOP SPEED XX KMPH
2	Best 0-60 kmph	Best Acceleration Achieved	BEST ACCELERATION
3	Achievement of every 1000 kms	Congrats travelled "xxxx" kilometers	TRAVELED XXXX KM
4	If the signal strength is poor	Poor network	POOR NETWORK
5	If the GPS signal is poor	Low GPS signal	GPS SIGNAL LOW
6	If the vehicle service date is due	Service due date	SERVICE DUE XX XXXX
7	Fuel low warning	Check fuel low	WARNING FUEL LOW
8	On receipt of an SMS	SMS	SMS RECEIVED
9	If mobile data is required for a particular feature but if mobile data is not ON	Turn on mobile data	TURN ON MOBILE DATA

<b>Sl. No.</b>	<b>Smart talk feature</b>	<b>Voice feedback</b>	<b>Display in cluster</b>
10	If Location access is not provided	Need GPS permission	NEED GPS PERMISSION
11	If location access is required for a particular function but if GPS is OFF	Turn on GPS	TURN ON GPS



## Terms & Conditions

- SmartXonnect feature is now enhanced with Voice Assistance capability. This will enable the user to control certain characteristics of the vehicle in a safe manner.
- Customers can use the voice commands listed as part of the voice assistance feature to improve their riding experience.
- SmartXonnect Voice Assistance is intended to minimize the use of Mobile phones while riding, in turn providing an exciting experience with the Bluetooth enabled system. We recommend users to take caution when providing voice commands.
- SmartXonnect Voice Assistance can be experienced with the help of following entities - TVS Connect App, TVS NTORQ Race Edition XP and a suitable Bluetooth accessory having a microphone and speaker. Users are recommended to wear certified helmets always while riding.
- In cases where customer uses a Bluetooth neckband or headset, it is recommended to always wear helmet.
- The Bluetooth® word mark and logos are registered trademarks owned by Bluetooth SIG, Inc., and any use of such marks by TVS Motor Company Limited., is under license.
- Customers must always be cautious of the surroundings when using the SmartXonnect Voice Assist feature, especially while crossing intersections, in traffic, etc. Customers must always observe the roadway, signs, and signals carefully. Lack of attention can cause serious injury or loss of life. TVSM is not liable for any such mishaps.
- Customers must always obey traffic laws while riding. TVSM is not liable for any penalty caused due to user's lack of caution in obeying traffic laws
- Costs of network communication and communication equipment necessary for the use of SmartXonnect voice assist feature shall be borne by the user himself/herself.
- Some smartphones may not be compatible with the SmartXonnect Voice Assistance feature. We shall not be liable if there is delayed response from the voice assistance feature due to poor internet connection or the phone's performance limitations.

- Use of mobile phones while riding is not safe and is prohibited as per Motor Vehicle law and rules as framed by central / state governments. Hence, Customers should not use the mobile phone while riding. We shall not be liable for any penalties, damages for any violation or trouble in the use of smartphone while riding.
- Bluetooth hands free devices are not included as part of the package
- SmartXonnect Voice assist feature also provides display information in the cluster. Users are advised to verify the voice guidance and information in the meter provided by the system carefully. If you are unsure, proceed with caution. Always use your own good judgement, and obey traffic laws while riding
- Changes in operating systems, hardware, software, and other technology integral to providing SmartXonnect Voice assistance feature, as well as new or revised governmental regulations, may result in a decrease or cessation of SmartXonnect Voice assist functionality and services. TVSM cannot and does not provide any warranty or guarantee of future SmartXonnect Voice assist performance or functionality.

## **LED HEAD LAMP CUM POSITION LAMP WITH ALL TIME HEAD LAMP ON (AHO)**

TVS NTORQ 125 Race XP comes with a LED head lamp cum position lamp. Position LED which glows automatically once the ignition is turned 'ON' and LED head lamp glows automatically when the engine is started, Only the head lamp beam (high/low) can be controlled by pressing the high/low beam switch.

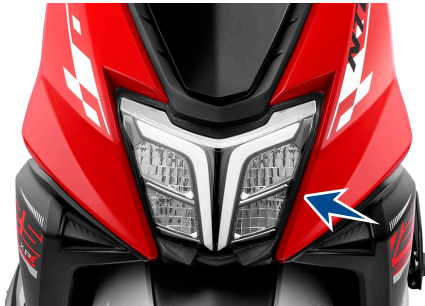

## FUEL TANK# CAP

Fuel tank is located at the rear end of the vehicle below the pillion holder.

To open the fuel tank cap, insert the control key into the 'seat cum fuel tank cap lock' and turn it in anti-clockwise direction. The fuel tank cap opens automatically. To close the cap, gently press the cap back to its position and ensure locking of the cap by hearing '**click**' sound.



# The fuel tank is not a measuring instrument and the capacity of the fuel tank may slightly vary from the indicated capacity.

### Warning

*Never refill fuel near open flame. Do not smoke while refueling. Do not use cell phones while refueling.*

### Caution

*Ensure that the fuel gun is inserted fully in the tank neck while refueling.*

*Whenever refueling, fill upto the bottom of neck portion (insert level) of the fuel tank. Filling above the neck may result in improper breathing of fuel tank and seepage of fuel.*

*While refueling, avoid spillage of petrol on the tyre. If fuel spills on tyre, the tyre will loose its grip on the road. Ensure to close fuel tank cap without fail to avoid fuel spillage.*

## EFFORTLESS E-Z CENTRE STAND

TVS NTORQ 125 Race XP is equipped with a effortless centre stand. The centre stand (1) has a pivoted flexible spring loaded lever arm (stand extension) (2) to increase the lever ratio, which enables parking on centre stand effortlessly and very conveniently.



To place the vehicle on centre stand, hold the handle bar left grip with left hand, place your foot firmly on the centre stand extension (2) while ensuring that both the stand shoes are touching the ground, press the stand extension.



### **Warning**

*Always retract the side stand to its full up position before moving the vehicle. Else, the vehicle will not get start.*

### **Caution**

*Never sit on vehicle when it is supported by stands. Always park the vehicle on a flat, firm surface.*

## SIDE STAND (mandatory accessory)\*



Side stand can be operated by sitting on vehicle with your left foot by pushing it away from the vehicle till it stops.

### Warning

*Always release the side stand to its full up position before starting the vehicle. Else the vehicle will not get start.*

\* Mandatory accessory will be charged extra

## KICK STARTER LEVER

The kick starter lever is located on the left side of the vehicle. To start the vehicle, park the vehicle on centre stand and keep the ignition in 'ON' condition. Move the lever extension (A) outwards and keep your foot on the lever extension. **Kick the lever from top and stroke to bottom with rapid motion.** Push back the lever extension to its original position once the vehicle is started.

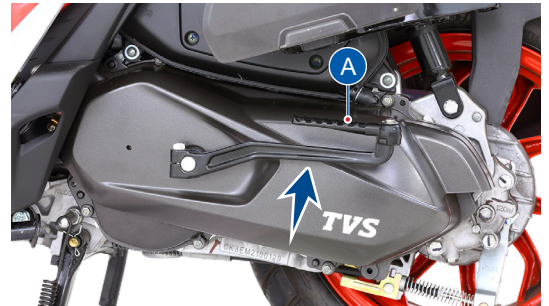

### Caution

*Put the vehicle on center stand before applying the kick starter lever to avoid kick lever hitting with center stand.*

## TOOL KIT AND FIRST AID KIT

To assist you in performing certain aspects of periodic maintenance and emergency repairs, a tool kit is supplied along with the vehicle and it is located below the seat base. To access the tool kit, insert the control key into seat lock and rotate it in clockwise direction. Lift and open the seat.

The tool kit consists one number each of the following. Ensure the contents of the tool kit.

1. 10x12 mm spanner
2. Combination screw driver bit
3. Screw driver handle
4. Tool bag



### Caution

*It is recommended to use the tool kit in case of any emergency only. It is always advisable to take your vehicle to TVS Motor Company Authorised Main Dealer / Authorised Dealer.*



## UTILITY BOX

Utility box is located below the seat. Lift the seat by unlocking the seat lock as explained in the previous page, to access the utility box.



## Caution

*Utility box can be used to carry a load of 10 kg maximum.*

*Do not carry perishable items inside the utility box. It is not fully sealed. Do not allow / spray water to get inside the utility box. Take care not to spill petrol or oil into the utility box.*

*Do not keep heat-sensitive items inside as it may get hot on long rides.*

*Do not keep valuable items inside the utility box when leaving the vehicle unattended.*



## Warning

*Operating the TVS NTORQ 125 Race XP overloaded will hamper riding stability and may lead to loss of control. Hence, it is advisable to carry the recommended amount of load only.*





## HELMET HOOKS

Two helmet hooks are provided under the seat assembly at front end near the seat hinge to secure your helmet. Open the seat assembly (refer page no. 73) to access the helmet hooks. Hook the helmet strap in the helmet hook properly and close the seat assembly.



## BAG HOOKS

There are two bag hooks provided with your scooter to carry light luggage like carry bags weighing upto 3 kg. One hook is located below handle bar on the rear panel.

Just pull out the hook from the top (A) to hang your luggage. Push back the hook once it is free.

Similarly, the other one is located on the cover front below front end of the seat assembly. Pull out the hook from its position. Open the top lid and hang your cargos. Lid will get close automatically. Push back the hook to its original position once it is free.

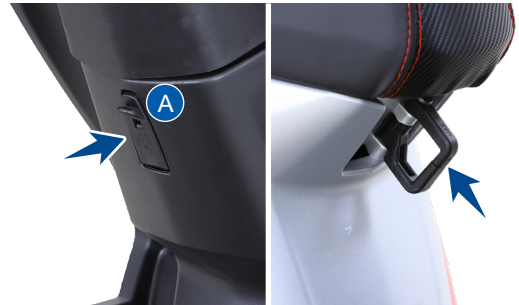

### **Caution**

*Care should be taken not to attach the luggage which hangs out of your scooter. Please note that the luggage attached to your scooter should not interfere your feet movement.*

## SMART PHONE CHARGER CUM UTILITY BOX LIGHT#

All new smart phone charger cum utility box light has been provided in the utility box of your vehicle (refer page no. 74). Please follow the guidelines mentioned below for using it properly:

### DO's

1. Ensure that no water enters into the unit, by closing the USB flap properly.
2. Ensure that the utility box light glass is not damaged while accessing the utilities.
3. Use the USB, if approved standard USB cable used for charging mobile.



4. Do make sure the flap (A) is not damaged while opening / inserting the USB cable.

### DON'Ts

1. Do not leave the USB charging flap open / partially closed.
2. Do not attempt to use / charge any other device, other than mobile phones. Only one mobile phone should be charged at a given time.
3. Do not slam / forcefully close the seat as it may permanently damage the utility box light switching mechanism.
4. Do not try to force the USB connector in, check whether it is inserted in the appropriate direction, to prevent the damage to the charger.
5. Do not charge your mobile when engine is off.

### Caution

*The charging time of the mobile may vary, depending on the mobile's battery state of charge. The rubber flap in the unit has been designed to prevent water entry and is not replaceable. No warranty for charger in case of rubber flap cut.*

*\* The smart phone charger cum utility box light will be a part of Disc Brake variant. For Drum Brake variant the same need to be purchased and fitted on the scooter.*

## PRE RIDE INSPECTION

Check the following items before riding

ITEM	WHAT TO CHECK FOR
Engine oil	Availability of oil upto the level (page no. 91)
Transmission oil	Availability of oil upto the level (page no. 92)
Fuel	Enough fuel for the planned distance of running
Tyres	Correct pressure (page no. 96) Adequate tread depth / No cracks or cuts.
Battery	Proper working of electric starter, horn, fuel gauge, pass by, brake lamp and turn signal lamps. Battery voltage (page no. 86)
Lighting	Proper working of head lamp high / low beam, DRL, high beam indicator, position lamp, connected instrument cluster back illumination, tail lamp and number plate lamp.
Steering	Smooth movement / no play or looseness
Throttle	Correct free play of cable / smooth operation
Brakes	Correct front / rear brake lever play (page no. 93) Availability of brake fluid and proper working of brake (page no. 93)
Wheels	Free rotation of front and rear wheels

## STARTING THE ENGINE

Ensure availability of adequate fuel in the fuel tank. Insert the control key into the ignition cum steering lock and turn it to the 'ON' position. Turn the engine kill switch to the 'O' position. In side stand retracted condition, apply any one of the brake and press the electric starter switch to start electrically or kick start.

### Setting the vehicle in motion

1. Twist the throttle grip slowly towards you and simultaneously release the brake lever gently and smoothly. The vehicle will start moving forward.
2. As the vehicle picks up speed, increase the throttle slowly.



### Caution

*Do not keep the engine in idling rpm for long and do not open excessive throttle when the vehicle is on side stand or off stand with brakes applied condition. It leads to overheating of engine and damage to the internal components.*



### Warning

*Do not raise the throttle rapidly so the vehicle will move forward suddenly and lead to loss of control.*

## Stopping and parking

1. Close the throttle completely and apply both the brakes simultaneously.
2. Turn engine kill switch to 'OFF' position.
3. Turn the ignition 'OFF'.
4. Park the vehicle on a firm, flat surface.
5. Lock the steering and take out the control key.



### Warning

*Reduce speed to a safe limit before turning / cornering. Do not apply brake while turning / cornering.*

## FUEL RECOMMENDATION

Use only BS VI petrol with minimum RON 91.

BS VI petrol containing upto 20% of ethanol by volume can be used.

Higher ethanol content in petrol can lead to

- degrade plastic and rubber components of fuel system and vehicle parts
- cause corrosion damage to metal parts like fuel tank, etc
- result in startability & drivability issues
- decrease fuel economy

Ethanol absorbs water very easily, resulting fuel separation. Extra care shall be taken to prevent moisture entry into fuel tank while filling ethanol blended petrol and water washing of vehicle.

Painted parts (viz. panels, covers) shall not come in contact with ethanol blended fuels. Manufacturer is not responsible for any warranty issues that results from using ethanol blend in excess of 20% by volume in petrol.

In case of any abnormalities observed due to use of ethanol blended fuels, customers are advised to use a different fuel station / brand for standard E20 fuel or contact authorised service centres.



### Caution

*Never mix oil in petrol in the fuel tank. Always fill fuel from the reputed and reliable fuel stations.*

## CHECKS AND TIPS FOR IMPROVING FUEL ECONOMY

### Regular checks

Carry out the periodic maintenance checks as specified in this manual (page no. 81).

Regular maintenance checks will save fuel and ensure trouble-free, enjoyable and safe riding besides keeping environment clean.

### Spark plug

A dirty or defective spark plug leads to wastage of fuel due to incomplete combustion. Clean and adjust the spark plug only if necessary. **Replace the spark plug every 12000 kms (1 year). Always use recommended spark plug only.**

### Air cleaner element

A dirty air cleaner element restricts airflow and increases fuel consumption. **Replace the element every 12000 kms.**

Since foam and paper type air filter element is used in your scooter, it is recommended to clean the foam filter element using mild compressed air from inside **every 3000 kms.** Replace the filters incase found any abnormalities.

### Engine oil and Transmission oil

Dirty or less engine oil increases the friction between various parts of the engine and reduces the engine life, thereby increases the fuel consumption.

Running with low transmission oil will cause damage to the gears and bearings.

**Regularly inspect the engine oil and the transmission oil for correct level and top-up if necessary. Get it replaced at regular intervals as per the maintenance schedule.**

### Fuel leak

Inspect and arrest fuel leaks if any from tank and fuel lines. Loss of fuel due to leak may drain the fuel tank completely.

### Evaporation

Vehicle parked in the hot sun leads to wastage of fuel through evaporation. Also, lower fuel levels in the tank will have increased evaporation and condensation of moisture inside.

Ensure to close fuel tank cap after every filling. If the fuel tank cap kept open for long time, it leads to safety and fuel loss.

### Tyres

Low tyre pressure has adverse effect on the vehicle. The **drag on the vehicle** increases resulting decreased fuel economy. Further more, handling may be adversely affected.

Inspect the tyre pressure regularly (weekly) and inflate it to the recommended pressure (refer page no. 96). Never use tyres which are worn beyond the permissible limit.

### Wheel freeness

Inspect and ensure the wheel freeness by rotating the wheel at least once in a week to avoid wastage of fuel.

### Avoid unnecessary idling

While waiting for someone or stopping in signals for long time, if the engine is kept running at idle speed, it causes unnecessary wastage of fuel.

### Avoid frequent braking

Anticipate corners and slopes as well as the traffic conditions. **Unnecessary and frequent braking will reduce the fuel economy. Never accelerate and apply brake simultaneously.** It leads clutch shoes wear and wastage of fuel.

### Note

*The on-road mileage of TVS NTORQ 125 Race XP is dependent on several factors like road condition, quality of fuel, riding speed, operation of clutch and brake, tyre inflation, maintenance / timely servicing of vehicle, load etc. and hence will differ from the mileage given under standard test conditions such as made in recognised institutes.*

## MAINTENANCE SCHEDULE

The maintenance schedule indicates the intervals between periodic services. At the end of each interval, be sure to inspect, check, replace, adjust, lubricate and service as instructed. If the maintenance is not done periodically, it will result in rapid wear and severe damage to the vehicle. If the vehicle is used under high stress conditions such as continuous full throttle operation or is used / operated in dusty area, certain jobs should be performed more often to ensure reliability of the vehicle. Cylinder head, steering components, suspension and wheel components etc., are key items and require very special and careful servicing. TVS Motor Company Limited strongly recommends that the jobs as per the maintenance schedule be performed by your TVS Motor Company Authorised Main Dealer / Authorised Dealer.

Periodic inspections may reveal one or more parts that may need replacement. Whenever replacing parts on TVS NTORQ 125 Race XP, it is recommended that you use only the TVS Motor Company Genuine parts.

### **Caution**

*Proper running-in and maintenance are mandatory for making certain that your vehicle is reliable and gives optimum performance at all times. Make sure that the periodic maintenance is performed thoroughly in accordance with the instructions given in this owner's manual.*

*In more dusty areas, the air filter elements required early inspection than the mentioned kilometers to avoid costly damages to the engine. If the elements are found with excessive dirt / clogged with dust, clean foam and paper elements using mild compressed air from inside. Replace the filters incase found any abnormalities.*

## PERIODIC MAINTENANCE SCHEDULE (months or km whichever occurs earlier)

Item	Service km Period from the date of sale	In free service				After free service		Remarks
		1st 500 - 750 2 months	2nd 2500 - 3000 4 months	3rd 5000 - 6000 8 months	4th 8500 - 9000 12 months	Every 3000 km 4 months	Every 6000 km 8 months	
Engine oil		R	I & T	R	I & T	I & T	R	
Oil filter (strainer)		C	-	C	-	-	C	
Transmission oil		R	I & T	R	I & T	I & T	R	
Spark plug		C & A	-	-	-	-	-	Inspect, Clean and adjust if required, Replace every 12000 km
Air cleaner (foam element)		I & C	I & C	I & C	I & C	I & C	-	Replace every 12000 km (as a set)
Air cleaner (paper element)		I	I	I	I	I	-	Replace every 12000 km (as a set)
Air cleaner oil collection tubes		-	I & DR	I & DR	I & DR	I & DR	-	Drain oil if necessary
CVT filter element <sup>1</sup>		-	-	I & C	-	-	I & C	Replace every 12000 km
Tappet clearance		I & A	-	I & A	-	-	I & A	Inspect for any noise / starting trouble and adjust if required
Drive belt and CVT rollers		-	-	-	-	-	-	Replace every 24000 km
Cover variator <sup>2</sup>		-	-	I, C & L	-	-	I, C & L	
Clutch shoe		-	-	-	-	-	-	Replace every 24000 km
Hose fuel		-	-	-	-	-	-	Inspect every service after four years, replace if required.
Front and rear suspension		I	I	I	I	I	-	Inspect for proper functioning

<sup>1</sup> Inspect for damage

<sup>2</sup> Clean the cover with air. Lubricate kick starter with Bechem grease

Contd...



Item	Service km Period from the date of sale	In free service				After free service		Remarks
		1st 500 - 750 2 months	2nd 2500 - 3000 4 months	3rd 5000 - 6000 8 months	4th 8500 - 9000 12 months	Every 3000 km 4 months	Every 6000 km 8 months	
All control cables <sup>3</sup>	I, A & L	I, A & L	I, A & L	I, A & L	I, A & L	-		
Throttle grip	-	-	L	-	-	L	Lubricate using grease	
Steering smooth operation / play	I & A	-	-	-	-	-	C, L & A with fresh grease every 12000 km	
Front fork oil	-	-	-	-	-	-	Replace every 24000 km	
All fasteners	I & TI	I & TI	I & TI	I & TI	I & TI	-		
All bulbs, horn and switches	I	I	I	I	I	-	Inspect for proper functioning	
Head lamp beam	I & A	I & A	I & A	I & A	I & A	-		
Battery voltage <sup>4</sup>	I	I	I	I	I	-		
Brake effectiveness / play	I & A	I & A	I & A	I & A	I & A	-	Refer page No. 58 & 61 for details	
Rear brake cam	-	-	C & L	-	-	C & L	Lubricate using grease	
Brake pad wear	I	I	I	I	I	-	Replace if necessary	
Brake fluid <sup>5</sup>	I & T	I & T	I & T	I & T	I & T	-		
Brake hose	I	I	I	I	I	-	Replace every three years	
Master cylinder cups	-	-	-	-	-	-	Replace every 21000 km	
Disc brake SBS cable play <sup>6</sup>	I	I	I	I	I	-	Inspect for brake levers rattling	

<sup>3</sup> Inspect for proper operation and adjust play. Lubricate ends using grease      <sup>4</sup> Recharge if necessary with MF battery charger

<sup>5</sup> Replace every 21000 km or 2 years whichever occurs earlier

<sup>6</sup> Adjust if rattling play is observed in both the brake levers

Cont ...

Item	Service km	In free service				After free service		Remarks
		1st 500 - 750 2 months	2nd 2500 - 3000 4 months	3rd 5000 - 6000 8 months	4th 8500 - 9000 12 months	Every 3000 km 4 months	Every 6000 km 8 months	
Wheel freeness		I	I	I	I	I	-	
Front wheel bearing		-	-	-	-	-	-	Lubricate using grease every 12000 km
Tyre pressure at cold condition		I & S	I & S	I & S	I & S	I & S	-	
Malfunction codes		I	I	I	I	I	-	Check and resolve the errors using diagnostic tool if the lamp is ON even after starting the engine
Evaporative emission control system		I	I	I	I	I	-	Check for intactness of hoses and canister
Fuel tank assembly**		I & C	I & C	I & C	I & C	I & C	-	
Centre / side stand pivot		L	L	L	L	L	-	Lubricate using TRU4 oil
Kick starter pedal pivot		L	L	L	L	L	-	Lubricate using TRU4 oil

R - Replace; I - Inspect; T - Top up; C - Clean; A - Adjust; DR - Drain; L - Lubricate; TI - Tighten; S - Set

\*\* Check for abnormal vehicle jerk / noise while opening the cap / leak. If found any, contact TVS Motor Company Authorised Main Dealer or Authorised Dealer.

## RECOMMENDED LUBRICANTS

APPLICATION	QTY	MANUFACTURER	BRAND
Engine oil	880 ml (during regular service) 930 ml (incase of disassembly)	TVS Motor Company	TVS TRU4 SKUUTA oil (SAE 10W/30 API-SL, JASO MB)
Transmission oil	120 ml (during regular service) 130 ml (incase of disassembly)	-do-	-do-
Front fork oil	91 ± 1 cc / leg	IOC / HPCL	Gabriel Premium front fork oil
Disc brake fluid	-	TVS Girling	DOT 3 / DOT 4
Grease	-	Bharat petroleum IOC Bechem Kluber Lubrication	MP Grease no. 3 Servo Gem no. 3 Bechem premium 3 Kluber Centoplex 2

## SELF - MAINTENANCE PROCEDURES

### MAINTENANCE FREE (MF) Battery

Battery is located at the front side of vehicle inside the front panel. The front panel must be removed to access the battery in the following manner:

1. Remove the front panel mounting screws.
2. Gently pull out the front panel by dislocating its lugs.
3. Reassemble the parts in the reverse order of dismantling.

Since the maintenance free battery is fitted on your vehicle it is not necessary to top-up with the distilled water.

But to ensure the battery performance and long life, follow the steps given below:

1. Check the battery voltage as per the schedule. If the voltage is less than 12.4 volts, charge the battery using **recommended MF battery charger** at TVS Motor Company Authorised Main Dealer / Authorised Dealer.
2. Do not add any additional electrical accessories other than recommended by TVS Motor Company Limited.
3. It is recommended to remove the negative (-) terminal first and then the positive terminal (+). Similarly, while connecting connect the negative terminal (-) first and then the positive terminal (+).

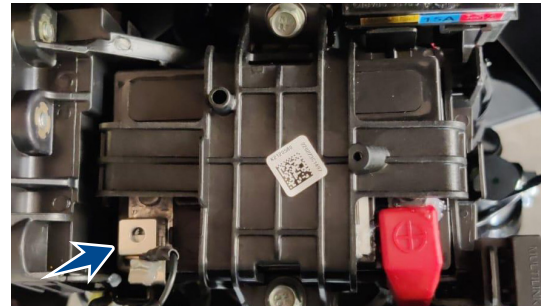

4. While connecting the terminals observe the correct polarity. Connect the red wire to the positive (+) terminal and the black wire to the negative terminal (-) of the battery.
5. Petroleum jelly must be applied at terminals to prevent it from corrosion.

Incase of any abnormality or for removal of battery from the vehicle, contact TVS Motor Company Authorised Main Dealer / Authorised Dealer.



### Caution

*Never check the battery charge by shorting the terminals. Always connect the positive terminal first (red wire) and then negative (black wire) to avoid sparking.*

*The inversion of the battery wires can damage the battery and the recharging system. Always connect the positive then negative to avoid sparking.*

\* To be done by skilled personnel

## Recommendations to maintain battery health during prolonged parking conditions

While your vehicle is parked for prolonged duration, battery continues to discharge and if left unattended can get completely discharged. It is recommended to ride the vehicle for minimum 60 km every week to keep the battery in healthy condition This could be at a stretch in one ride or several rides during the week.

The vehicle speed will vary during the ride but an average speed of minimum 30 kmph will be helpful to ensure proper battery charging. Use kick-starting, if available, to conserve battery charge during such period. This is only a recommendation to maintain battery charge and regular service schedules must be followed to maintain your vehicle in good running condition.

The following is recommendations to users regarding battery maintenance before, during and after long storage of battery:

### 1. Before Storage

- a. Store the battery only after fully charging it
- b. Battery fuse to be disconnected and stored safely. This will reduce the sleep mode current and hence enhance storage life of battery.\*

- c. Alternatively, battery connecting wires (positive and negative wires) can be disconnected and fasteners can be secured with battery terminals.\*

## 2. During Storage

- a. Store it at room temperature or lower.
- b. Store the vehicle in the shade and protected from rain and cover the vehicle to prevent rodents from entering and damaging the wires.

## 3. After Storage

- a. Connect the wires and fuse, if disconnected earlier, with ignition switch in OFF position\*
- b. Start the vehicle by kick starting.

(Above recommendations do not consider storage effects on other systems such as induction and fuel systems and wheels)

### Periodic Maintenance of Batteries:

- Keep top of battery clean
- Check cables, clamps, and case for obvious damage or loose connections
- Clean terminals and connectors as necessary
- Recharge battery if voltage is below 12.4 Volts.

\* To be done by skilled personnel

- Valve Regulate Lead Acid (VRLA) / Lead Acid batteries are prone to water damage. Any water entry, through vents or otherwise; will result in irreparable damage to the battery or the vehicle.

### **Warning**

*Battery develop explosive gases. Keep it away from heat sources. If charging is required the battery must be charged in well ventilated area.*

*Unusable battery must be disposed in environment friendly manner. Do not discard it with household trash. Handover the battery to the battery dealers or to a recycle center that accept used battery.*

### **Caution**

*Never operate the vehicle with discharged battery as it may damage electrical components.*

## FUSE

Non-working of electrical systems may be due to safety fuse failure. Short circuit or overload in the electrical system are the main causes for fuse failure. There is a fuse case containing three blade type fuses (15A x 1 and 10A x 2) located near the battery. Follow the procedure given below for inspecting and replacing the fuse.

1. Turn 'OFF' the ignition.
2. Remove the front panel as explained earlier.
3. Take out the fuse case from the battery holder.
4. Open the fuse case and pull out the fuse.



Good Fuse

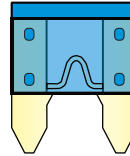

Blown Fuse

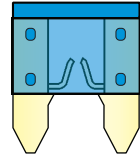

5. Inspect the fuse for failure. If found defective Replace the blown fuse with a new (extra fuses are provided in the wiring harness itself in a pouch).
6. Close and refit the fuse case back to its position.
7. Turn 'ON' the ignition lock and check for proper functioning of the electrical systems. In case the fuse fails again, consult the nearest TVS Motor Company Authorised Main Dealer / Authorised Dealer.

### **Caution**

*Do not use vehicle by shorting the wires without fuse. This may result in overheating of electrical items / wiring and may result in fire of vehicle.*

*Do not use fuse of higher amperage than specified for the safety of electrical system.*

## SPARK PLUG

To access the spark plug, the cover front has to be removed. Follow the bellow procedure to remove the cover front.

1. Remove the bottom mounting screws (A) of cover front.
2. Open the seat and remove the top mounting screws (B) from both the sides of cover front.
3. Gently pull out the cover front by dislocating its lugs.
4. Clean the dust and mud around the spark plug mounting to avoid falling inside the cylinder.

5. Pull out the suppressor cap from spark plug.  
Using the spark plug spanner, remove the spark plug.

A spark plug with heavy carbon deposits will not produce strong sparks. Hence, only if necessary, clean the carbon deposits from the spark plug with a small wire brush or spark plug cleaning tool.

Inspect the spark plug electrodes (A) and (B) for any corrosion. If found any replace the spark plug with new. Visually inspect the spark plug gap. The gap should be **0.9 ~ 1.0 mm**. If the gap is found to be more than the limit, replace the spark plug with a new one.

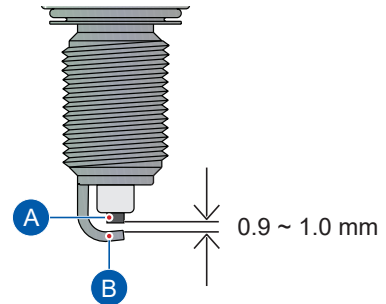
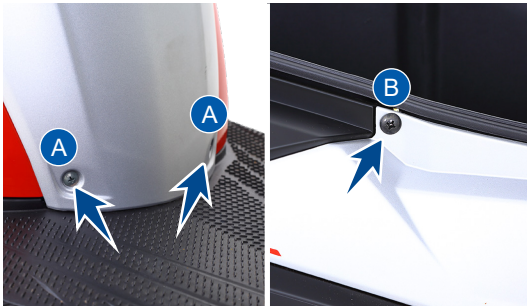



After cleaning and inspecting the gap, reinstall the spark plug and tighten by hand to avoid cross threading. Finally tighten using spark plug spanner. Do not over tight or cross thread the spark plug.

 **Caution**

*Always use only recommended make and type of spark plug. Replace spark plug every 12000 km.*

*Don't remove the spark plug when the engine is hot. Cover the spark plug hole with a cloth when the plug is removed to prevent entry of dust / water.*

*Do not try to adjust the spark plug as it may damage the plug. Replace the plug if the gap is found more.*

*It is advisable to tighten the new spark plug by hand till the end, using plug spanner tighten by 1/4 turn. Then loosen the plug by 1/8 turn and re-tighten using plug spanner.*

## ENGINE OIL LEVEL

Check the engine oil level periodically.

1. Place the vehicle on centre stand on a flat surface. Wipe-off the surroundings of gauge oil level.
2. Remove the gauge and wipe it clean.
3. Fix the gauge back to its mounting hole. Do not thread in.
4. Take out the gauge and check the oil level. The level should be between minimum and maximum level marks of the gauge (shown in the figure).
5. If the oil is less than the minimum level, add 'TVS TRU4 SKUUTA oil (SAE 10W30 API-SL, JASO MB)' upto the maximum level mark.

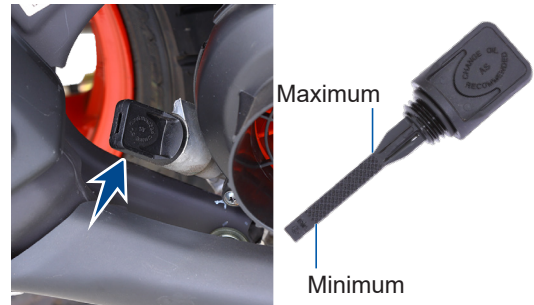

6. Wipe out the oil traces with a clean cloth to prevent dust accumulation.
7. Assemble back the gauge oil level.

 **Caution**

*If the vehicle is driven with less engine oil, the engine components will be severely damaged.*

*Check the oil level as per the schedule to avoid costly damage. Do not fill excess oil may cause oil leak. Always use 'TVS TRU4 SKUUTA oil only (SAE 10W30 API-SL, JASO MB)'*

### TRANSMISSION OIL - LEVEL

Check the transmission oil level periodically.

1. Place the vehicle on centre stand on a flat surface.
2. Wipe-off the surroundings of oil level screw.
3. Remove the transmission oil level screw along with a gasket from the rear end of crankcase L.
4. Check for the flow of oil from oil level hole.
5. If the level is less (if there is no oil flow), top-up with 'TVS TRU4 SKUUTA oil (SAE 10W30 API-SL, JASO MB)' till the oil just starts to flow out from the oil level hole.



6. Wipe out the oil traces with a clean cloth to prevent dust accumulation.
7. Replace the fiber washer while reassembling the oil level screw.

 **Caution**

*If the vehicle is driven with less transmission oil, the transmission components of engine will be severely damaged.*

*Check the oil level as per the schedule to avoid costly damage. Do not fill excess oil may cause oil leak. Always use 'TVS TRU4 SKUUTA oil only (SAE 10W30 API-SL, JASO MB)'*

## BRAKES

### Front brake

You can observe a master cylinder (1) right side of the handle bar under the head lamp housing.

A caliper assembly (2) fitted to the fork leg L, a disc (3) on the front wheel and a high pressure hose (4) connecting the master cylinder and the caliper assembly.

1. Check the master cylinder brake fluid level through the view piece glass (A).
2. The brake fluid level always should be above the 'LOWER' mark (B) provided on the view piece glass of the master cylinder when the cylinder is parallel to ground.



3. If the brake fluid level is below the mark or while applying brake if you feel the brake is more spongy or ineffective due to air entry, contact TVS Motor Company Authorised Main Dealer or Authorised Dealer for topping-up the brake fluid, air bleeding and other brake related inspections.

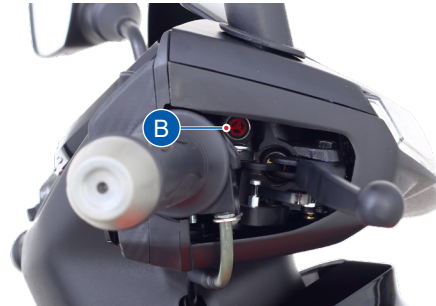

### Caution

*Master cylinder brake fluid level must be checked only when the master cylinder is parallel to the ground.*

### Brake pad wear indicator (Disc brake)

Check for the wear of brake pads visually. If the brake pads wear is found beyond the wear indicator groove as shown in the figure, replace the brake pads as a set with a new one.

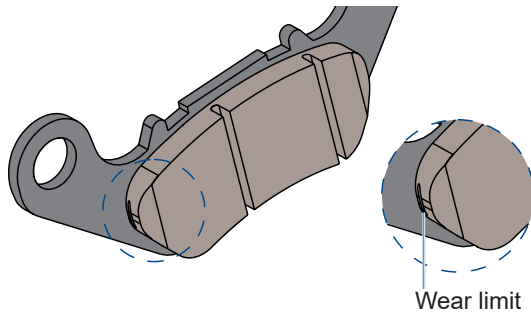

#### **Caution**

Replace the brake pads as a set, if the wear indicator shows beyond the wear limit.

#### **Warning**

Disc brake SBS cable need to be adjusted incase if rattling is found in both brake levers.

### Rear brake (Drum brake)

1. Measure the free play of the rear brake lever at the lever end as shown in the figure.
2. Free play of brake lever before the engagement of brake should be between 10 ~ 15 mm.
3. If the measured distance is more than the limit, adjust the nut provided at the rear wheel end to obtain the correct play.



#### **Warning**

Check front brake (drum brake type) and rear brake play periodically. However the brake play needs to be adjusted more frequently depending upon the usage.

- Turn the adjuster nut in clockwise direction for reducing free play or in anti-clockwise direction for increasing the free play.



### Note

Please remember that the rear brake lever free play adjustment to be done only after adjusting the front brake lever play incase of SBS type brake (Drum type).

### Brake shoe wear indicator (Rear brake)

When brake is applied, the wear limit indication pointer (1) on the rear brake cam lever should be within the wear limit indicator (2) on the crankcase LH.

In case the wear limit indication pointer (1) is going beyond wear limit indicator (2), index the lever to next slot with the help of Dealers to extend shoe life.



### Caution

Replace the brake shoes as a set, if the wear limit indicator shows beyond the wear limit even after indexing the lever.

## TYRES

### Tyre pressure

Check the tyre pressure atleast once in a week if not more frequently. Insufficient air pressure in the tyres not only hasten tyre wear, but also seriously affects the stability of the vehicle.

Under inflated tyres make smooth cornering difficult and over inflated tyres decreases the tyre contact with the ground which can lead to skidding and loss of control.

Be sure that the tyre pressure is within the specified limit at all times.

#### Tyre pressure in cold condition:

	Solo	Dual
Front	1.69 kg/cm <sup>2</sup> (24 PSI)	1.69 kg/cm <sup>2</sup> (24 PSI)
Rear	2.25 kg/cm <sup>2</sup> (32 PSI)	2.53 kg/cm <sup>2</sup> (36 PSI)

### Tyre tread condition

Operating the vehicle with excessively worn tyres will decrease riding stability and can lead to loss of control. It is recommended to replace the tyre when the tyre wears off to the tyre wear indicator level (indicated by TWI (A) on the tyre).



### Warning

*The tyre inflation pressure in cold condition and the tyre tread condition are extremely important for the performance and safety of the rider. Check the tyres frequently for inflation pressure as well as the wear pattern on it. Use of a tyre other than the standard may cause instability.*

### **Tyre rotation direction**

While reassembling the tyre on the wheel rim, please ensure the following:

1. The front tyre (indicated by 'FOR FRONT FITMENT' on the tyre) should not be assembled to rear wheel rim.
2. The arrow mark on the tyre should match the actual direction of rotation of wheel (both front and rear wheels).

### **Tyre puncture**

Your scooter is fitted with a tubeless tyre on both front and rear wheel. In case of any puncture / tyre damage, it is advised to visit the nearest tyre manufacturer Dealer or the tyre repair shops who knows the repairing method of tubeless tyre.

It is not necessary to remove the tyre from wheel rim always to attend a puncture, Even though it there is need of tyre removal, it is strongly recommended to use a tyre removal / fitment machine. If at all, tyre levers needs to be used, the levers should be free from sharp edges. Care should be taken not to damage the tyres and rims.



### **Caution**

*The side walls of the tubeless tyre which in contact with the wheel rim are only seals the air inside the wheel assembly. Hence care should be taken not to damage the side walls of the tyres during removal / reassembly.*

## Tyre Maintenance Tips

### Inflation Pressure Check - Condition



Within  
1 km



Within  
5 km

### Note

*If vehicle is in hold condition for long time*

- *Need movement of vehicle to avoid particular spot of tyre not to touch the ground for more than week time.*
- *Inflation pressure should check on cold condition maximum travel time should not exceed more than 1 km.*
- *Weekly basis inflation pressure check helps to improve 10% of tread life & fuel efficiency.*



## FRONT WHEEL REMOVAL AND REASSEMBLY

1. Remove the axle nut (1) along with a washer.
2. Pull out the axle (2) along with a washer and take out a spacer from the left side of the wheel.
3. Place a support below the foot board to prevent vehicle from falling and lift the vehicle up.
4. Dislocate the wheel disc from caliper assembly and take out the wheel along with hub drive.
5. Reverse the procedure for reassembling. Ensure the proper seating of wheel disc in the caliper assembly and lug on fork leg R to the slot in the hub drive while reassembling.



## REAR WHEEL REMOVAL AND REASSEMBLY

1. Place the vehicle on the centre stand.
2. Hold the rear brake firmly and remove the wheel mounting nut (1) along with a washer.
3. Slightly tilt the vehicle and take out the wheel from the rear axle.
4. Reassemble the wheel in the reverse order of removal.



### **Caution**

*Always make sure, whenever the wheel is removed, the axle nuts are tightened properly to the specified torque.*

## STORAGE PROCEDURES

For storage of your scooter for longer period of over a month and above, we recommend to carry out the following steps:

1. Clean the vehicle thoroughly. Park the vehicle on centre stand.
2. Warm up the engine and drain engine oil and transmission oil. Store the oil, if new, in a dust free container.
3. Empty the fuel tank.
4. Remove the spark plug and feed in several drops of engine oil through spark plug hole. Crank the engine few times and reinstall the spark plug.
5. Remove the battery, store it away from direct sunlight and freezing temperatures.
6. Place a suitable support at the bottom of the foot board so that both the tyres are off the ground. This will ensure better tyre life.
7. Cover up the vehicle completely with a clean tarpaulin or any other suitable cover. Store the vehicle inside a garage or similar area to avoid damage due to dust and rain. Make sure that the storage area is well ventilated and free from any source of flame or spark.



### Caution

*Do not park the vehicle on a slope or soft ground or else it may fall down.*

*The exhaust system becomes hot after a run. Park the vehicle in a place where pedestrians or children are not likely to touch the vehicle.*

*During storage, the battery must be recharged at recommended charger if stored more than a month.*

## TAKING THE VEHICLE OUT OF STORAGE FOR REGULAR USE

1. Take the vehicle out of garage and clean it thoroughly.
2. Remount the battery after bench charging if required.
3. Fill the engine oil (TVS TRU4 SKUUTA oil - SAE 10W30 API-SL, JASO MB) and check the oil level using gauge oil level.
4. Fill the transmission oil (TVS TRU4 SKUUTA oil - SAE 10W30 API-SL, JASO MB) and check the oil level at the oil level screw.
5. Lubricate the parts as instructed in the periodic maintenance schedule.
6. Fill up fresh petrol in the fuel tank.
7. Check and inflate the tyres to the specified tyre pressure.
8. Check and correct the points mentioned in page No. 77.
9. Turn the ignition switch to 'ON' position. Turn ON the engine kill switch. Retract the side stand if the vehicle is parked on side stand. Start the vehicle and ride out.



### Caution

*Avoid using alkaline solution like detergent soaps for washing. This may damage head lamp and other lamp assemblies.*

## RECOMMENDED TIPS WHEN TAKING A LONG TRIP OF MORE THAN 500 KM:

- A) Please keep the following items for use in case of emergency:
1. Tool kit complete.
  2. Recommended spark plug one number.
  3. Turn signal lamp bulb each one.
  4. Throttle and rear brake cable each one.
  5. First aid kit.
- B) Precautions to be taken for the journey:
1. Ensure engine oil and transmission oil are up to the level.
  2. Adequate fuel in the fuel tank.
- C) Check your scooter for the following:
1. Tightness of all bolts and nuts with correct torque value.
  2. Fitness of tyres / tyre pressure / tread depth.
  3. All bulbs, indicators and horn functioning.
  4. Smooth functioning of all cables and their free play.
  5. Smoothness of steering operation.
  6. Front / rear brake function and rear brake lamp working.

7. Front fork for any abnormality.
8. Spark plug gap and condition of spark plug.
9. Air filter element cleanliness.
10. Lubrication of all items mentioned in the periodic maintenance schedule.
11. Any other job as necessary.
12. Have your vehicle checked at any TVS Motor Company Authorised Main Dealer or Authorised Dealer.



### Caution

*Long journey are to be taken only after the running-in period of 1000 km.*

**TVS Motor Company Limited ('the Company') give this warranty with respect to the TVS NTORQ 125 Race XP manufactured by the Company.**

While the Company has taken every care to maintain quality in the manufacture of the TVS NTORQ 125 Race XP, the above said warranty is subject to other terms of warranty:

During 5 years from the date of purchase or during the first 50,000 km of run for the vehicle in the hands of original retail purchaser, whichever is earlier, the parts of the vehicle covered under warranty which prove to the satisfaction of the Company to have a manufacturing defect will be repaired or replaced free of cost.

The Company's obligation under this warranty is limited to repairing or replacing, free of cost, those parts of the vehicle which upon examination by the Company may prove to the Company's satisfaction to have a manufacturing defect, and in such cases the Company's decision either to repair or replace the affected parts will be final. In the event of replacement of parts, the Company also reserves the right to use parts of the same brand as the affected parts or any other brand which is used by the Company in the course of manufacture. All parts replaced under this warranty will become the property of the Company and must be returned to the company.

**Limitations of Warranty:**

This warranty shall not apply to following condition:

1. Any natural wear and tear, including without limitation, aging.
2. Warranty claims on proprietary items such as tyres, tubes and batteries etc., should be preferred by the user directly on the respective manufacturer, as per their warranty terms and the Company shall not be liable in any manner in respect to the same.
3. Parts repaired or replaced under this warranty are warranted only throughout the remainder of the original warranty period.
4. The Company is not liable for any delay in servicing due to reasons beyond the control of the Company or any of its Authorised Main Dealers / Authorised Dealers.
5. In any event, the Company is not liable for indirect, remote, incidental or consequential damages.

6. The Company may make any modification or improvement to vehicles in future production at any time without prior notice and without any obligation to install the same on vehicles previously dispatched for sale.
7. Any claim under this warranty will lie only when the customer:
  - takes his vehicle to an Authorised Main Dealer / Authorised Dealer of the Company and reports the problem he / she felt in the vehicle to enable the Authorised Main Dealer / Authorised Dealer to inspect the same and assess the cause for the reported problems.
  - produces to such Authorised Main Dealer / Authorised Dealer the Service Handbook for the concerned vehicle for verification of relevant details.
8. This is the only warranty given by the Company for the TVS NTORQ 125 Race XP. No employee, Dealer or other person is authorised to extend or enlarge this warranty.

 **Warning**

*Modifications to this vehicle not approved by the TVS Motor Company may cause loss of performance and render it unsafe for use and disqualifies for warranty coverage also.*

**Following Toll Free numbers can be contacted for battery related queries if any.**

Incase of EXIDE battery, call :- 1800 103 5454

Incase of AMCO battery, call :- 1800 425 0096

Incase of TATA GREEN battery, call :- 1800 419 8888

Incase of AMARON battery, call :- 1800 425 5858

**Following Toll Free numbers can be contacted for Tyre related queries if any.**

Incase of TVS Srichakra, call :- 04522443300

Incase of JK tyre, call :- 18002581100

Incase of Maxxis tyre, call :- 1800 532 2888

## List of parts not covered under warranty

ITEM	WHAT TO CHECK FOR
Normal Maintenance operations	Engine tune-up, decarbonizing, fuel system cleaning, oil changes, head light focusing, fastener retightening, ignition timing, clutch and brakes as well as other normal adjustments.
Wear & tear items	Chain, sprockets, clutch and brake linings, fasteners, shims, washers, oil seals, gaskets, O' rings and spokes etc.
Electrical	Bulbs , fuse, DRL, AHO
Service Maintenance Parts	Oil filters, spark plug, air filter, SAI filter, oils and brake fluid
Rubber, rexine & plastic items	All hoses, pipes and plastic aesthetics
Proprietary Items	Battery, tyres and tubes (the warranty terms are subject to our agreement with proprietary OEM)
Others Factors	Parts of the vehicle getting affected due to atmospheric effect / environmental factors (rusting, paint peel off etc.). However, depending on the vehicle usage condition, warranty would be accepted up to 2 years from the date of purchase.
	Parts of the vehicle which have been tampered with, altered, repaired or replaced by persons not authorised by the Company and which in the sole judgement of the Company affect the performance of the vehicle.
	Parts which are used in conjunction with parts not made or recommended by the Company.

## List of parts not covered under warranty

ITEM	WHAT TO CHECK FOR
Others Factors	Parts suffering damage or resultant damage by accident, misuse, negligent treatment, use of bad quality lubricants or impure fuel or by omission to follow the guidance and instructions contained in this owner's manual.
	Vehicles on which engine number or chassis number is deleted, defaced or altered. Vehicles on which any warranty service including scheduled paid service is not availed when it falls due (at TVS Motor Company Authorised Main Dealer / Authorised Dealer).
	Vehicles sold or transferred by original retail purchaser. Vehicles used for racing or any competition or used otherwise than for ordinary personal transportation. Vehicles attached with side cars etc. Vehicles which have been taken out of India. Vehicles affected by natural calamities like flood, earthquake, tsunami, storm etc,.
	If the vehicle has been used for commercial purpose like taxi or used for rental or hiring or any other purpose other than regular personal transportation.



## SERVICE INFORMATION

There are seventeen services for TVS NTORQ 125 Race XP during warranty period. Of these, first four services are free services for which labour charges are free. In addition to these four free services, we have a scheme of thirteen pay services. For keeping the maintenance track of your vehicle, free and pay service record sheets are attached in the Service Handbook given to you during the time of your vehicle purchase. Please have the relevant record sheet filled by the Dealer who is carrying out the maintenance service.

For availing any of the warranty services, please take your vehicle and your Service Handbook to any of our Authorised Main Dealers or any of our Authorised Dealer. After effecting the service the Authorised Main Dealer or the Authorised Dealer will affix their stamp on the last column of free or pay service record sheet of Service Handbook for your record and reference. An OTP would be sent to customer's registered mobile number. The same to be shared with the servicing Dealer on or before vehicle delivery.

Periodic maintenance always helps good performance of an automobile and our services are planned to keep your TVS NTORQ 125 Race XP performing good. **Please note that carrying out the services for your vehicle at scheduled intervals at any of the TVS Motor Company Authorised Main Dealer / Authorised Dealer is necessary for availing of warranty.** And please also remember that, after the services are over, periodic servicing of your vehicle at appropriate intervals, depending upon its extent of use, will keep your vehicle at its best level of performance.

In case you need any clarification or assistance, please feel free to write to us mentioning the frame number, engine number and date of purchase of your vehicle also the name and place of the Authorised Main Dealer / Authorised Dealer from whom you bought the vehicle and getting it serviced.

### Service Department

**TVS MOTOR COMPANY LIMITED**

**P.O. Box No. 4, Harita, Hosur - 635 109,**

**TAMILNADU, INDIA.**

**Toll free no:- 1800-258-7111**

**Planned Service Schedule (kms or month whichever of the two occurs early)\***

Sl.No.	Service	Type	Kms	Months
1	1st Service	Free	500 ~ 750	2
2	2nd Service		2500 ~ 3000	4
3	3rd Service		5000 ~ 6000	8
4	4th Service		8500 ~ 9000	12
5	5th Service	Pay	11500 ~ 12000	16
6	6th Service		14500 ~ 15000	20
7	7th Service		17500 ~ 18000	24
8	8th Service		20500 ~ 21000	28
9	9th Service		23500 ~ 24000	32
10	10th Service		26500 ~ 27000	36
11	11th Service		29500 ~ 30000	40

Sl.No.	Service	Type	Kms	Months
12	12th Service	Pay	32500 ~ 33000	44
13	13th Service		35500 ~ 36000	48
14	14th Service		38500 ~ 39000	51
15	15th Service		41500 ~ 42000	54
16	16th Service		44500 ~ 45000	57
17	17th Service		47500 ~ 48000	60

### Note

**Free service enables the customer to avail the service at free of labour charges. Charges for the pay service should be borne by the customer. Cost of engine oil, periodic maintenance parts, filter, brake fluids, all types of greases, petroleum jelly, distilled water, chain cleaner, lubricants, coolants, cleaning cloths for both free and paid services are chargeable to the customer.**

*\* Please remember that, after the above schedule, periodic servicing of your vehicle at appropriate intervals, depending upon its extent of use, will keep your vehicle at its best level of performance.*

**MANUFACTURER** : TVS MOTOR COMPANY LIMITED  
P.B. No1, Bythahalli, Kadakola post, Mysore - 571 311, India.

TVS MOTOR COMPANY LIMITED  
Village Bhatian, Bharatgarh Road, Teh Nalagarh, Dist. Solan.  
Himachal pradesh - 174 101, India.

### ENGINE

Type : Single cylinder, 4 stroke, fuel injection, air cooled, spark ignition engine

Cylinder bore : 53.5 mm

Stroke : 55.5 mm

Piston displacement : 124.8 cc

Compression ratio : 10.3 : 1

Air filter : Dry paper filter with dry foam

Oil filter : Wire mesh

Lubrication system : Forced wet sump

Maximum power in kW : 6.6 kW @ 7000 rpm (Street mode)  
: 7.5 kW @ 7000 rpm (Race mode)

Maximum torque in Nm : 10.0 Nm @ 5500 rpm (Street mode)  
: 10.9 Nm @ 5500 rpm (Race mode)

Maximum speed : 89 km/h (Street mode)  
: 98 km/h (Race mode)

Engine idling rpm<sup>†</sup> : 1500 ± 100 rpm (Street mode)  
: 1750 ± 100 rpm (Race mode)

Starting system : Electric starter / kick starter

Emission norms : BSVI

### TRANSMISSION

Clutch : Dry - Centrifugal clutch

Primary transmission : CVT (Continuous Variable Transmission)

Primary reduction : 2.65 to 0.8

Secondary reduction : 9.085

### CHASSIS

Overall length : 1861 mm

Overall width : 710 mm

Overall height : 1164 mm

<sup>†</sup> Under warm condition

## CHASSIS

Ground clearance	: 155 mm (unladen)
Wheel base	: 1285 mm
Kerb weight (with toolkit and 90% of fuel)	: 111 kg
Pay load	: 130 kg
Maximum laden weight	: 241 kg
Frame	: Under bone tubular frame
Front suspension	: Telescopic hydraulic
Rear suspension	: Toggle link, gas filled hydraulic damper
Steering angle	: 90°
Caster angle	: 25°

## TYRE

### Tyre size

Front	: 100/80 - 12 56L Tubeless
Rear	: 110/80 - 12 61L Tubeless

### Tyre pressure

Front	: 1.69 kg/cm <sup>2</sup> (24 PSI)
Rear - solo	: 2.25 kg/cm <sup>2</sup> (32 PSI)
Rear - dual	: 2.53 kg/cm <sup>2</sup> (36 PSI)

## BRAKES

Front	: 220 mm dia Disc (hand operated)
Rear	: 130 mm dia Drum (hand operated)

## ELECTRICAL

Ignition system	: ECU controlled ignition
Spark plug	: BOSCH - UR5KCW / CHAMPION - RG8MC4
Spark plug gap	: 0.9 to 1.0 mm
Battery type	: 12V, 4Ah / 3Ah MF battery
Generator	: Fly wheel magneto 12V, 130W
Head lamp with AHO	: 12V, LED
DRL / Position lamp	: 12V, LED
Tail / brake lamp	: 12V, 1/2W LED
Turn signal lamp	: 12V, 10W x 4
Number plate lamp	: 12V, 5W
Instrument cluster	: LCD / LED indicators
Horn	: 12V, 2.5A DC
Fuse	: 15A x 1 (Blade type) : 10A x 2 (Blade type)



### Caution

*Using the bulb other than the specified rating can result in overloading of the electrical system or premature failure of the bulb.*

## CAPACITIES

Fuel tank capacity#	: 5.8 l
Fuel	: BS VI petrol with minimum RON 91 (containing upto 20% of ethanol by volume)
Engine oil grade	: TVSTRU4 SKUUTA oil (SAE 10W30 API-SL, JASO MB)
Engine oil capacity	: 880 ml (during regular service) 930ml (incase of disassembly)
Transmission oil capacity	: 120 ml (during regular service) 130ml (incase of disassembly)
Front fork oil grade	: IOC / HPCL / Castrol - Gabriel Premium front fork oil
Front fork oil capacity	: 91 ± 1 cc per leg
Brake fluid	: TVS Girling DOT 3 / DOT 4

### Note

*Specifications are subject to change without notice.*

# The fuel tank is not a measuring instrument and the capacity of fuel tank may slightly vary from the indicated capacity.

## GENERAL INFORMATION

Dear Customer,

It is mandatory under the Motor Vehicles Act to insure all motor vehicles. No motor vehicle can be used in a public place without a valid policy of insurance issued by an authorised insurer. Driving a motor vehicle without any such insurance is an offense under Motor Vehicles Act.

To assist our Customers on their insurance requirements such as the prompt issue and renewal of policies as well as expeditious settlement of claims if any, our preferred insurers are:





ALWAYS USE TVS-M GENUINE PARTS





**TVS MOTOR COMPANY LIMITED**

*P. B. No. 4, Harita, Hosur - 635 109, Tamil Nadu, India.*

*Telephone: +91 (4344) 276780 | Fax: +91 (4344) 277311/276878*

*Website: [www.tvsmotor.com](http://www.tvsmotor.com) | Toll-free No.: 18004252077*